

Antiretroviral Medications and Initial Therapy

This is a PDF version of the following document:

Module 3: [Antiretroviral Therapy](#)

Lesson 1: [Antiretroviral Medications and Initial Therapy](#)

You can always find the most up-to-date version of this document at

<https://www.hiv.uw.edu/go/antiretroviral-therapy/general-information/core-concept/all>.

Background

The availability of highly effective antiretroviral therapy in the mid-1990s transformed HIV from a fatal infection to a manageable, chronic disease. Persons with HIV who take modern combination antiretroviral therapy and maintain virologic suppression significantly reduce their HIV-associated morbidity and mortality, and do not transmit HIV to others.[1,2,3] The United States Food and Drug Administration (FDA) has approved medications in six different classes to treat HIV infection: entry inhibitors, nucleoside reverse transcriptase inhibitors (NRTIs), non-nucleoside reverse transcriptase inhibitors (NNRTIs), integrase strand transfer inhibitors (INSTIs), protease inhibitors (PIs), and capsid inhibitors (Figure 1).[4,5] This Topic Review will summarize the mechanism of action of antiretroviral medications, indications for antiretroviral therapy, and recommended antiretroviral regimens for treatment-naïve individuals. Separate Topic Reviews will address other issues related to antiretroviral therapy, including adverse effects, drug interactions, simplifying or switching therapy, assessment of drug resistance, and management of virologic failure. In addition, detailed information about each antiretroviral medication and for all fixed-dose combinations is available in the [Antiretroviral Medication](#) section of this website.

HIV Life Cycle and Antiretroviral Drug Targets

Understanding the basic HIV life cycle is the foundation for understanding the mechanism of action of the different classes of antiretroviral medications. The following discussion will focus on key HIV enzymes and relevant steps in the HIV life cycle related to HIV antiretroviral therapy.

[Activity] B. HIV Life Cycle Video

HIV Entry and Entry Inhibitors

HIV Envelope

The initial step in the HIV life cycle involves a complex interaction between HIV envelope spikes and host surface proteins. The HIV envelope consists of two structural components: surface envelope glycoprotein (gp120) and transmembrane envelope glycoprotein (gp41) ([Figure 2](#)).^[6] The surface of HIV is studded with approximately 14 envelope spikes, with each spike consisting of a trimer of three gp120 and gp41 subunits.^[7,8] Both gp120 and gp41 play an essential role in HIV entry into the host cell.

- **gp120:** The gp120 subunit is the component of the envelope that interacts with the host receptors and coreceptors; these interactions involve the gp120 CD4 binding site on the outermost surface of gp120 and the more internal variable 3 (V3) region of gp120. The gp120 V3 region plays a major role in determining the coreceptor tropism of HIV.
- **gp41:** The gp41 subunit consists of three domains: the ectodomain (in the extracellular region), the transmembrane domain (spans the HIV membrane), and the cytoplasmic tail (inside the HIV membrane).^[9,10,11] Prior to cell binding, the HIV gp41 exists in a conformation in which the gp41 is folded back on itself in an energy-loaded state.

HIV Entry

The HIV entry process involves a sequential and coordinated interaction between the virus and the host cell that includes three key steps: (1) attachment of HIV gp120 with the host CD4 receptor, (2) HIV gp120-host chemokine coreceptor binding, and (3) gp41-mediated fusion of HIV with the host surface membrane.^[6,12]

- **Attachment:** After initial nonspecific interactions between HIV and the host cell, the HIV gp120 attaches to the host CD4 receptor, with binding occurring at the CD4 binding pocket on HIV gp120 and the extracellular domain 1 (D1) of the CD4 receptor.^[13]
- **Coreceptor Binding:** Following the initial gp120-CD4 receptor attachment, the HIV gp120 undergoes rearrangement, with the formation of a bridging sheet and repositioning of the V3 loop. This rearrangement allows the HIV gp120 V3 loop to interact with a host chemokine coreceptor (CC)—either the CCR5 or CXCR4 coreceptor ([Figure 4](#)). The HIV coreceptor binding (CCR5 or CXCR4) depends on the HIV subtype (R5 or X4), which is determined primarily by the HIV gp120 V3 region.
- **Fusion:** The HIV gp120-coreceptor interaction is believed to activate the gp41 fusion machinery, which triggers the unfolding of the gp41, with the insertion of the distal end of gp41 (gp41 fusion peptide) into the host cell membrane.^[6,13] Next, the three gp41 subunits undergo a hairpin-like fold, which causes the HIV and host membranes to be pulled toward each other, generating HIV-host cell membrane fusion.^[6,13]

HIV Entry Inhibitors

The FDA-approved HIV entry inhibitors include four subclasses: (1) CD4 attachment inhibitors; (2) CD4 postattachment inhibitors, (3) CCR5 coreceptor antagonists, and (4) fusion inhibitors.^[14,15] Note that the CD4 attachment inhibitor and the fusion inhibitor bind directly to HIV, whereas the postattachment inhibitor and the CCR5 coreceptor bind human cell surface receptors ([Figure 5](#)).

- **Attachment Inhibitor:** The early interaction of HIV with the host CD4 cell involves binding of the HIV gp120 envelope protein with the host CD4 receptor. The attachment inhibitor fostemsavir is an oral prodrug that is hydrolyzed to the active form temsavir, which binds to the HIV gp120 envelope adjacent to the gp120-CD4 binding site.[16,17] The binding of temsavir prevents the gp120 conformational change required for normal attachment to the CD4 receptor.[16]
- **Postattachment Inhibitor:** The initial attachment of HIV to the CD4 cell occurs between the domain 1 region of the host CD4 receptor and the HIV gp120 binding site. Ibalizumab, a humanized monoclonal antibody, binds to the domain 2 region of the host CD4 receptor, and, through steric hindrance, prevents the normal structural shifts that occur in gp120 that result in gp120-coreceptor binding; the net effect of ibalizumab is the prevention of viral entry.[18,19] Ibalizumab acts at a step following the initial attachment of CD4 domain 1 to HIV gp120, so it is referred to as a postattachment inhibitor. It is important to note that ibalizumab does not interfere with CD4-mediated immune function since it does not interfere with CD4 binding of major histocompatibility complex (MHC) class II molecules, which occurs at the CD4 domain 1 region. Ibalizumab is available only as an intravenous infusion.
- **CCR5 Receptor Antagonists:** The appropriate use of CCR5 antagonists depends on knowledge of the person's HIV subtype. There are three HIV subtypes related to host coreceptor binding: R5 HIV (binds only to the CCR5 coreceptor); X4 HIV (binds only to the CXCR4 coreceptor); dual-tropic HIV (binds to either the CCR5 or CXCR4 coreceptor).[20,21] Individuals with a mixture of R5 HIV and X4 HIV have mixed-tropic HIV. The CCR5 antagonists bind to the CCR5 coreceptor, causing a conformational change in the coreceptor that prevents HIV gp120 from binding to the CCR5 coreceptor.[20,22] The CCR5 antagonists do not effectively block the entry of X4, dual-tropic, or mixed-tropic HIV. The drug maraviroc is the only FDA-approved CCR5 antagonist, and it is recommended for use in antiretroviral treatment-experienced individuals only if they have documented R5 HIV. Thus, prior to starting maraviroc, an HIV coreceptor tropism assay must be performed.[20,22,23]
- **Fusion Inhibitor:** In the normal fusion process, the HIV gp41 heptad repeat region 2 folds back on the heptad repeat region 1, in essence zipping up the gp41. This process pulls the HIV and host membranes together and results in the fusion of the viral and host membranes. The fusion inhibitor enfuvirtide is a 36-amino-acid synthetic peptide that corresponds to a 36-amino-acid segment in the HIV gp41 heptad repeat region 2; the enfuvirtide peptide binds to the heptad repeat region 1 of gp41, thus preventing the normal interaction and folding of the gp41 heptad repeat regions 1 and 2.[21,24,25] Enfuvirtide is the only FDA-approved fusion inhibitor, but it is no longer available in the United States.

Reverse Transcription and Reverse Transcriptase Inhibitors

HIV Reverse Transcriptase

The HIV reverse transcriptase enzyme catalyzes the critical HIV reverse transcription process. This enzyme is a heterodimer consisting of the p66 and p51 subunits (Figure 6).[26,27] The p66 subunit, which primarily has a catalytic role, consists of the polymerase and RNase H domains. Conceptually, the polymerase domain is structurally analogous to a human right hand, with specific regions corresponding to fingers, palm, and thumb.[27] The p51 subunit has a structural role and is very closely related, but not identical to, the polymerase domain of the p66 subunit. Each HIV-1 virion contains approximately 50 reverse transcriptase enzymes.[26]

Reverse Transcription

The reverse transcription of HIV is a multistep process that results in a copy of linear, double-stranded HIV DNA being generated from single-stranded HIV RNA.[26,28] Each HIV-1 virion contains two copies of plus-stranded genomic RNA. Conceptually, the key steps in reverse transcription are the conversion of single-stranded HIV RNA to single-stranded HIV DNA, followed by digestion of the HIV RNA, and finishing with the formation of double-stranded HIV DNA from the single-stranded HIV DNA. The HIV reverse transcriptase

enzyme plays a central role during reverse transcription, and the enzymatic activities that occur involve the polymerase and RNase H active sites. During this process, the HIV reverse transcriptase polymerase domain functions to add host nucleotides to the expanding strand of DNA, whereas the RNase H digests unwanted fragments of HIV RNA and HIV DNA. During the process of reverse transcription, the HIV reverse transcriptase incorporates host nucleotides into the elongating primer strand, which forms opposite to the HIV template strand ([Figure 7](#)).[\[26\]](#)

Reverse Transcriptase Inhibitors

The HIV reverse transcriptase inhibitors include two classes of antiretroviral medications: nucleoside reverse transcriptase inhibitors (NRTIs) and non-nucleoside reverse transcriptase inhibitors (NNRTIs). Mechanistically, the fundamental difference between these classes is that the NRTIs insert into the elongating HIV DNA chain, whereas the NNRTIs bind directly to the HIV reverse transcriptase enzyme and inhibit the enzyme function.

- **Nucleoside Reverse Transcriptase Inhibitors (NRTIs):** The NRTIs require intracellular phosphorylation to obtain an active state. Once triphosphorylated, the NRTIs mimic human nucleotides and can be interchangeably taken up by reverse transcriptase for incorporation into the elongating chain of HIV DNA strand.[\[27,29,30,31\]](#) There are two subtypes of NRTIs: obligate chain terminators and translocation inhibitors.
 - **Obligate Chain Terminators:** Unlike human nucleotides, the NRTI obligate chain terminators do not have a 3'-hydroxyl group, and additional nucleotides cannot be added to the NRTI drug. The inability to add further nucleotides results in immediate chain termination. These medications are also referred to as obligate (or immediate) chain terminators ([Figure 8](#)).[\[27,29\]](#)
 - **Translocation Inhibitors:** The primary mechanism for the NRTI translocation inhibitors is to prevent the normal movement (translocation) of the reverse transcriptase enzyme on the HIV primer and template. This occurs due to the 4'-ethynyl side chain that binds to the HIV reverse transcriptase, which essentially tethers the chain in place on the enzyme.[\[32,33\]](#) The secondary mechanism of action involves delayed chain termination. Unlike the obligate chain terminators, the translocation inhibitors have a 3'-hydroxyl group, and this allows for the addition of another nucleotide.[\[32,33\]](#) The additional nucleotide alters the elongating strand, distorting it in such a way that no further nucleotides are incorporated. Thus, if translocation is not completely blocked, delayed chain termination plays a role.[\[32,33\]](#)
- **Non-nucleoside Reverse Transcriptase Inhibitors:** The NNRTIs bind to a hydrophobic pocket in the p66 subunit, which is close to the active polymerase site ([Figure 9](#)).[\[34,35\]](#) Binding of the NNRTI causes hyperextension of the reverse transcriptase “thumb” region, which causes a conformational change in this polymerase domain, thereby blocking the process of DNA polymerization, a critical step in HIV reverse transcription.[\[34,36\]](#)

HIV Integration and Integrase Strand Transfer Inhibitors

HIV Integrase

The HIV integrase enzyme is a 288-amino-acid protein that consists of three distinct structural domains: the amino (N)-terminal domain, the catalytic core domain, and the carboxy (C)-terminal domain; the catalytic core domain contains a trio of amino acids that coordinate binding with a divalent metal cofactor (either Mg^{2+} or Mn^{2+}), and this region forms the active catalytic site ([Figure 10](#)).[\[37,38,39\]](#) The HIV integrase enzyme can exist in the form of a monomer, dimer, tetramer, and possibly higher-order forms, such as octamers. Each HIV-1 virion has an estimated 40 to 100 integrase enzymes.[\[39\]](#)

HIV Integration

For replication, retroviruses must integrate the linear, double-stranded HIV DNA formed by reverse transcription into the host DNA. The integration of HIV DNA into host DNA is a multistep process, and the HIV

enzyme integrase performs two key catalytic reactions: 3' processing of the HIV DNA and strand transfer of the HIV DNA into the host DNA.[38,39,40] Initially, the HIV integrase binds to each end of the newly formed HIV DNA as part of an intracellular nucleoprotein particle known as the preintegration complex (Figure 11).[38] The DNA-bound integrase removes two nucleotides on the 3'-ends of the DNA, forming sticky ends that are capable of inserting into the host DNA.[40] Inside the nucleus, the preintegration complex is released when the HIV capsid core disassembles. The strand transfer reaction occurs when the integrase enzyme catalyzes the attack by the HIV DNA 3'-hydroxyl group on the host DNA, which opens up the host strand of DNA, allowing for the HIV DNA to be inserted into the host DNA. In the final step, cellular enzymes perform DNA gap repair, which smooths over the HIV-host DNA junctions.[40]

Integrase Strand Transfer Inhibitors

The HIV integrase inhibitors block the integrase strand transfer step and are thus referred to as integrase strand transfer inhibitors (INSTIs).[41,42] The INSTIs bind to magnesium ions in the active site of the HIV integrase enzyme, which impairs the activity of the enzyme (Figure 12).[38,43] In addition, upon binding to the magnesium ions, the INSTIs displace the HIV DNA 3'-hydroxyl ends, which interrupts the integration process since the 3'-hydroxyl ends are the critical nucleophiles during the transfer of the strand of HIV DNA into the host DNA.[43] By these mechanisms, binding of the INSTI to the integrase enzyme prevents the HIV complex from integrating into the host DNA.[40,43]

HIV Protein Processing and HIV Protease Inhibitors

HIV Protease

The HIV protease enzyme is a 99-amino-acid dimer comprised of two identical subunits (Figure 13). This enzyme has a key role in the post-transcriptional processing of the Gag (Pr55) and Gag-Pol (Pr160) polyproteins.[44] The HIV protease has three major conformational forms: open, semi-open, and closed. The protease enzyme has an active site near the center of the heterodimer that includes two opposed aspartic acid (Asp) residues. Movement from the open to closed form causes the protease flap ends to overlap, which functionally acts as molecular scissors.

Polyprotein Processing and Maturation

Protease-related polyprotein processing occurs in a consistent sequential pattern. The Gag polyprotein contains four structural proteins: matrix (p17), capsid (p24), nucleocapsid (p7), and p6 proteins. During approximately 5 to 10% of the Gag translation events, a ribosomal frameshift occurs that results in translation of the Gag-Pol polyprotein.[45] The Gag-Pol polyprotein includes the same structural Gag proteins, with the addition of the Pol functional enzymes (protease, reverse transcriptase, and integrase).[46] The HIV protease initially catalyzes its own release from the Gag-Pol polyprotein strand. Once the HIV protease is untethered, it processes both the Gag-Pol and the Gag polyproteins. The HIV protease polyprotein processing of the Gag protein occurs in a predictable sequential cascade (Figure 14).[45,47,48] The timing of the polyprotein processing occurs late in the HIV replication cycle, typically during and shortly after the virus is released from the host cell. The processing of the Gag and Gag-Pol polyproteins releases the matrix, capsid, nucleocapsid, p6, protease, reverse transcriptase, and integrase proteins.[47]

Protease Inhibitors

The HIV protease inhibitors are structurally complex molecules that bind to the active site of HIV protease and inhibit protease enzyme activity (Figure 15).[44,45] The HIV protease inhibitors disrupt the normal Gag and Gag-Pol polyprotein processing, causing the arrest of the normal maturation process, which thereby prevents infection of new cells. The protease inhibitors do not have an impact on cells already infected with HIV (those with proviral DNA integrated into the host DNA).

HIV Capsid and Capsid Inhibitors

HIV Capsid

The cone-shaped HIV capsid—also called the capsid core or the core—encases the viral genome and enzymes necessary for reverse transcription—reverse transcriptase and integrase.[49,50] The HIV core is a conical, hollow shell composed of the HIV p24 proteins, which are also referred to as capsid proteins (CA) (Figure 16). The capsid proteins self-assemble, forming hexamer and pentamer rings; each mature HIV capsid core consists of approximately 200 capsid hexamers and exactly 12 capsid pentamers.[50]

Capsid Assembly and Disassembly

The capsid is crucial for several stages of the HIV life cycle. After HIV entry into the CD4 host cell, the HIV capsid core enters the cytoplasm and subsequently migrates to the nucleus along the host cell microtubule network.[49,51] After reaching the nuclear pore, the core migrates through the nuclear pore complex into the nucleus.[51] During migration to and through the nuclear pore, the capsid core shields the viral genome and facilitates the reverse transcription process, which occurs inside the core.[49] Beginning late in the transport and late in the reverse transcription process, the capsid core begins to disassemble (or uncoat) and this process is eventually completed after the capsid core is transported inside the nucleus. The disassembled capsid core releases the reverse-transcribed viral genome (now double-stranded DNA) for integration into the host DNA.[51] Later in the viral life cycle, the Gag and Gag-Pol polyproteins are cleaved, releasing individual capsid (p24) protein monomers, which assemble into hexamers and pentamers, and these larger subunits assemble into the cone-like capsid core in a process referred to as capsid assembly.[51] This latter stage of the life cycle is called viral maturation.[51]

HIV Capsid Inhibitors

The HIV capsid inhibitors are a unique class of antiretroviral medication; these medications interfere with the structure and function of the HIV capsid and thereby block multiple steps in the HIV lifecycle pathway (Figure 17).[52] Lenacapavir is the only drug in this class that has been approved by the FDA. Lenacapavir binds within a pocket between the capsid subunits of two different capsid proteins, thereby reducing the flexibility of the interhexamer connections.[52,53,54] Lenacapavir inhibits viral replication at three steps in the HIV life cycle: (1) it disrupts the normal transport of the capsid core through the nuclear pore complex, (2) it prevents the uncoating or disassembly of the capsid, and (3) it interferes with reassembly of the capsid core as part of the HIV maturation process.[52,55]

When to Initiate Antiretroviral Therapy

Recommendations for Initiation of Antiretroviral Therapy

The Adult and Adolescent ARV Guidelines recommend initiation of antiretroviral therapy for all persons with HIV to reduce morbidity and mortality associated with HIV infection and to prevent HIV transmission to others ([Table 1](#)).^[56] In addition, antiretroviral therapy should be started immediately, or as soon as possible, after the HIV diagnosis.^[56] Further, the guidelines emphasize the importance of starting antiretroviral therapy as soon as possible in people diagnosed with acute or early HIV infection, due to both immunologic consequences of delayed initiation and the elevated risk of transmitting HIV during this period.^[56]

Data for Clinical Benefit of Antiretroviral Therapy

The Adult and Adolescent ARV Guidelines recommendation to initiate antiretroviral therapy in all persons with HIV to reduce morbidity and mortality is based on multiple cohort studies and clinical trials, as outlined below. Collectively, these trials have shown a clear benefit of starting antiretroviral therapy early in the course of HIV disease progression.^[2,57,58,59,60,61]

Data for Antiretroviral Therapy Reducing HIV Transmission

The recommendation in the Adult and Adolescent ARV Guidelines regarding the use of antiretroviral therapy to prevent HIV transmission is based on multiple studies that indicate antiretroviral therapy dramatically lowers the risk of sexual transmission of HIV and perinatal transmission of HIV.^[3,62,64] These studies are outlined in detail in the Module 5 lesson [Preventing HIV Transmission in Persons with HIV](#).

Recommendations for Elite and Viremic Controllers

A very small percentage of persons naturally control HIV RNA levels without medications and are considered "elite controllers" of HIV. These individuals have a unique immunologic response to HIV that results in persistent control of plasma HIV RNA to levels consistently below the limit of quantitation. These individuals also usually maintain long-term control of CD4 cell count levels above 500 cells/mm³.^[65] Similarly, a larger but still small subset of individuals with HIV, referred to as "viremic controllers," have the ability to naturally maintain plasma HIV RNA at very low, but not undetectable, levels.^[65] Viremic controllers also usually have high CD4 cell counts but typically have less stable and lower CD4 cell counts than elite controllers.^[66]

Initiating Antiretroviral Therapy for Elite and Viremic Controllers

The optimal antiretroviral management of elite controllers and viremic controllers has generated controversy, since without antiretroviral therapy, these individuals naturally control HIV RNA levels and theoretically would pose minimal risk of transmitting HIV to others. These individuals, however, may still have an increased risk of non-AIDS-related morbidity from immune activation, and a significant proportion will eventually lose their immunologic control of HIV and experience disease progression.^[65,67,68] The Adult and Adolescent ARV Guidelines make the following key recommendations for elite controllers:^[56]

- Antiretroviral therapy is strongly recommended for elite controllers if they: (1) have evidence of HIV disease progression (HIV-related complications, declining CD4 count, or intermittently detectable HIV RNA levels), (2) have significant medical comorbidities (cardiovascular disease, cancer, viral hepatitis, or others), or (3) are pregnant (to prevent perinatal transmission).
- The initiation of antiretroviral therapy is recommended for all elite controllers, even in the absence of the criteria listed above, albeit with a weaker level of recommendation. The reason for the weaker recommendation is that the clinical benefit of antiretroviral therapy in elite controllers who do not have HIV disease progression remains uncertain. That said, elite controllers have increased immune activation and markers for increased risk of atherosclerosis, so there is a theoretical benefit to giving

antiretroviral therapy to elite controllers to reduce immune activation and potential non-AIDS morbidity.

- If antiretroviral therapy is not given to elite controllers, close follow-up should occur since some of these individuals lose their natural control of HIV.

Antiretroviral Therapy Initiation in Hospitalized Persons with HIV

For an individual diagnosed with HIV during a hospitalization, consideration should be given to the benefits of starting antiretroviral therapy during the inpatient stay.[\[56\]](#) If there are no contraindications, the Adult and Adolescent ARV Guidelines recommend starting antiretroviral therapy in the hospital whenever possible.[\[56\]](#) If antiretroviral therapy is started in the hospital, efforts are needed to ensure a transition plan and medication continuation plan after discharge.[\[56\]](#)

Antiretroviral Regimens for Initial Therapy

The Adult and Adolescent ARV Guidelines stratify antiretroviral regimens for initial therapy as (1) *Recommended Initial Regimens for Most People with HIV* or (2) *Other Initial Antiretroviral Regimens for Certain Clinical Scenarios*. The category *Recommended Initial Regimens for Most People with HIV* is further subdivided based on whether the person has a history of receiving long-acting cabotegravir as HIV preexposure prophylaxis (PrEP).^[69] Choosing an initial antiretroviral regimen depends on multiple factors, including medical comorbidities, potential drug interactions, insurance coverage, and patient preferences (pill burden, frequency of dosing, and food requirements).

Recommended Initial Regimens for Most People with HIV

The Adult and Adolescent ARV Guidelines *Recommended Initial Regimens for Most People with HIV* treatment options depend on whether the individual has previously received long-acting injectable cabotegravir.^[69]([Table 2](#))

- **For People Who Have Not Received Long-Acting Cabotegravir for PrEP:** The *Recommended Initial Regimens for Most People with HIV*, in the setting of no history of receiving long-acting cabotegravir as HIV PrEP prior to HIV diagnosis, include an INSTI anchor drug in combination with at least one NRTI.^[47,69] All of these regimens can be dosed once daily. Note that dolutegravir-lamivudine should not be used as initial therapy in the following three situations: (1) the baseline HIV RNA level is greater than 500,000 copies/mL, (2) the person undergoing treatment has chronic hepatitis B virus (HBV) or the HBV status is unknown, or (3) results from HIV genotypic resistance testing or hepatitis B serology are not available at the time antiretroviral therapy is planned to start.^[69] The other recommended regimens can be initiated prior to the availability of genotype resistance test results.
- **For People Who Received Long-Acting Cabotegravir for PrEP:** For individuals diagnosed with HIV who have a history of receiving long-acting cabotegravir for HIV PrEP, the initial antiretroviral therapy should consider potential integrase resistance. The reason for this concern is that injectable cabotegravir, an INSTI, has an extremely long half-life and can remain at quantifiable levels in plasma for months to years (up to 4 years for some individuals). Thus, a person who acquires HIV after stopping long-acting cabotegravir may have levels of cabotegravir that are inadequate for the prevention of HIV acquisition but may be high enough to stimulate the development of integrase resistance. Therefore, for people with prior injectable cabotegravir use, baseline genotypic integrase resistance testing should be obtained. In addition, antiretroviral therapy should be initiated with boosted darunavir (darunavir-cobicistat or darunavir plus ritonavir) with two NRTIs—tenofovir alafenamide (or tenofovir DF) plus emtricitabine (or lamivudine)—while awaiting the drug resistance testing results. If a baseline integrase genotype does not show evidence of INSTI resistance, one can then change the boosted darunavir to a recommended INSTI, such as dolutegravir or bictegravir.

Recommended Initial Regimens in Certain Clinical Situations

Multiple antiretroviral regimens are available that are effective and tolerable but are not generally preferred [due to certain disadvantages or less efficacy data](#), as compared to the regimens listed above. The Adult and Adolescent ARV Guidelines denote this category as *Other Initial Antiretroviral Regimens for Certain Clinical Scenarios* ([Table 3](#)).^[69]

Special Considerations for Women of Childbearing Potential

The Adult and Adolescent ARV Guidelines have specific recommendations for women trying to conceive or who are sexually active and not using effective contraception, and may become pregnant.^[70,71] Based on updated data, preferred options when there is a potential for pregnancy include bictegravir-tenofovir alafenamide-emtricitabine or dolutegravir plus preferred NRTI backbone (tenofovir alafenamide or tenofovir

DF, with either emtricitabine or lamivudine).[70,71] The Perinatal HIV Clinical Guidelines recommend the same preferred options during pregnancy.[70,71,72] Thus, if a woman is taking one of these preferred antiretroviral regimens and becomes pregnant, she can continue on the same regimen.[72] Ritonavir-boosted darunavir (in combination with a preferred NRTI backbone) is also a preferred option for use during pregnancy, though it may have more side effects and drug interactions. In addition, the ritonavir-boosted darunavir requires twice-daily dosing during pregnancy.[71,72]

Choosing a Specific Antiretroviral Regimen

Factors to Consider for Selecting an Initial Regimen

In clinical practice, several specific clinical scenarios exist that may warrant consideration for the use of certain regimens. The following summarizes the recommendations in the Adult and Adolescent ARV Guidelines.^[73]

- **History of Prior Exposure to Long-Acting Cabotegravir:** If an individual diagnosed with HIV has received long-acting cabotegravir in the past, results of an integrase genotype should be available prior to initiating an INSTI-based regimen. If initiating antiretroviral therapy prior to the availability of integrase genotype results, the recommended initial antiretroviral regimen is boosted darunavir plus (tenofovir alafenamide or tenofovir DF) with (emtricitabine or lamivudine). If resistance testing shows no integrase resistance, the regimen can be switched to an INSTI-based regimen, if desired.
- **Pretreatment HIV RNA Level:** Rilpivirine-anchored regimens should not be used with pretreatment HIV RNA levels greater than 100,000 copies/mL due to higher rates of virologic failure. In addition, dolutegravir-lamivudine should not be used when the pretreatment HIV RNA level is greater than 500,000 copies/mL based on limited data.
- **Pretreatment CD4 Cell Count:** Higher rates of virologic failure have occurred with rilpivirine-anchored regimens when the pretreatment CD4 count is less than 200 cells/mm³.
- **Treatment of HIV Before Drug Resistance Results Available:** It is essential to use an antiretroviral regimen that has a high genetic barrier to resistance in the situation when treatment is initiated prior to the availability of the HIV genotypic drug resistance test results. In general, NNRTI-based regimens should be avoided in this setting. The following regimens are recommended in this situation:
 - Bictegravir-tenofovir alafenamide-emtricitabine
 - Dolutegravir plus (tenofovir alafenamide or tenofovir DF) plus (emtricitabine or lamivudine)
 - Darunavir (boosted with ritonavir or cobicistat) plus (tenofovir alafenamide or tenofovir DF) plus (emtricitabine or lamivudine)
- **Need for Baseline HLA-B*5701 Testing:** If abacavir is under consideration for use, baseline HLA-B*5701 testing must be performed. Abacavir is rarely used in clinical practice nowadays, especially as part of an initial regimen. This antiretroviral medication should never be prescribed if the HLA-B*5701 test is positive due to a risk of life-threatening hypersensitivity reactions.
- **Food Requirements:** The NRTI backbone combinations of abacavir-lamivudine, tenofovir DF-emtricitabine, and tenofovir alafenamide-emtricitabine can be taken with or without food. The INSTI dolutegravir can be taken with or without food. The single-tablet regimens bictegravir-tenofovir alafenamide-emtricitabine, dolutegravir-abacavir-lamivudine, dolutegravir-lamivudine, doravirine-islatravir, and doravirine-tenofovir DF-lamivudine can also be taken with or without food. The following medications should be taken with food: rilpivirine, darunavir boosted with ritonavir, darunavir boosted with cobicistat, and elvitegravir boosted with cobicistat.
- **Chronic Kidney Disease:** For persons who have a pretreatment estimated glomerular filtration rate (eGFR) less than 60 mL/min, any regimen containing tenofovir DF should be avoided. If the eGFR is less than 30 mL/min (and the patient is not receiving hemodialysis), any regimen containing tenofovir alafenamide-emtricitabine should be avoided.
- **Osteoporosis:** In patients with known osteoporosis, tenofovir DF or any fixed-dose combination that contains tenofovir DF should be avoided.
- **Mental Health Conditions or Dementia:** Efavirenz, and possibly rilpivirine, have been associated with worsening of psychiatric symptoms, and consideration should be given to avoiding these medications in persons with a mental health disorder or dementia.
- **Hyperlipidemia:** The INSTIs bictegravir, dolutegravir, and raltegravir are considered lipid neutral. Tenofovir DF does not increase lipids and in some it may slightly lower lipid levels. The following medications often cause dyslipidemia: ritonavir-boosted PIs, cobicistat-containing regimens, and efavirenz.

- **Concern for Excess Weight Gain:** Use of INSTIs, particularly bicittegravir-tenofovir alafenamide-emtricitabine and dolutegravir plus tenofovir alafenamide-emtricitabine, has been associated with more weight gain after starting antiretroviral therapy as compared to older regimens, such as regimens that contain efavirenz or a boosted protease inhibitor as the anchor drug, or regimens that contain tenofovir DF as a component of the NRTI backbone. The mechanisms and long-term implications have not been confirmed, and the guidelines do not recommend altering the choice of an initial antiretroviral regimen based on this observation.
- **Cardiac QTc Interval Prolongation:** Since efavirenz, rilpivirine, and fostemsavir may prolong QTc, they should be avoided in persons taking other medications that may prolong QTc.

Choosing the Anchor Drug in an Initial Antiretroviral Regimen

The choice of the third drug, commonly referred to as the anchor drug, to combine with an NRTI backbone for an initial antiretroviral regimen depends on clinical, pharmacologic, and patient-level factors. In the Adult and Adolescent ARV Guidelines, the *Recommended Initial Regimens for Most People with HIV* utilize the INSTI bicittegravir or dolutegravir for the anchor drug (as long as the individual diagnosed with HIV has never received cabotegravir for HIV PrEP). The recommendation to use these two INSTIs as the anchor drug is based on high efficacy, high genetic barrier to resistance, low adverse effect profile, and minimal drug interactions.[\[69\]](#)

Choice of INSTI

In the Adult and Adolescent ARV Guidelines, two of the INSTIs (bicittegravir and dolutegravir) are included as the anchor drug component of the *Recommended Initial Regimens for Most People with HIV* (assuming the patient has never received cabotegravir for HIV PrEP).[\[69\]](#) Note that bicittegravir is available only as a fixed-dose combination with tenofovir alafenamide and emtricitabine. In Study 1490, initial therapy with bicittegravir-tenofovir alafenamide-emtricitabine showed similar virologic responses as dolutegravir plus tenofovir alafenamide-emtricitabine.[\[30\]](#) Bicittegravir and dolutegravir have emerged as the most attractive INSTI-based options primarily because of their high genetic barrier to resistance, relatively good tolerability, minimal drug interactions, and recommended use in pregnancy.

Choice of PI

The Adult and Adolescent ARV Guidelines recommend boosted darunavir as the anchor drug in the category *Other Initial Antiretroviral Regimens for Certain Clinical Scenarios*. In addition, boosted darunavir is a preferred anchor drug option if a person has received long-acting cabotegravir for HIV PrEP or in the rare circumstance when baseline integrase resistance is suspected.[\[69\]](#) For initial therapy, darunavir is dosed once daily (with food) and boosting can be achieved with either ritonavir or cobicistat.

Choice of NNRTI

Doravirine and rilpivirine are the NNRTI anchor drugs available in the category of *Other Initial Antiretroviral Regimens for Certain Clinical Scenarios*.[\[69\]](#) Rilpivirine should not be used in persons who have a current HIV RNA level greater than or equal to 100,000 copies/mL or a current CD4 count less than or equal to 200 cells/mm³.[\[69,73\]](#) In addition, rilpivirine is contraindicated for individuals who are taking a proton pump inhibitor, and it must be taken with food.[\[69\]](#) Doravirine is well tolerated, can be taken with or without food, and can be used in combination with proton pump inhibitors. Doravirine is available alone as a tablet or in the coformulated single-tablet regimens doravirine-tenofovir DF-lamivudine and doravirine-islatravir.

Choosing the NRTI Backbone in an Initial Regimen

The Adult and Adolescent ARV Guidelines include three different dual NRTI backbone combinations: tenofovir alafenamide-emtricitabine, tenofovir DF-emtricitabine, and tenofovir DF-lamivudine.[\[69\]](#) Tenofovir DF can

cause renal dysfunction and loss of bone mineral density; accordingly, tenofovir DF is not recommended for patients with renal disease or osteoporosis. Tenofovir alafenamide has a less favorable lipid profile than tenofovir DF. The guidelines also include one option as preferred initial therapy that only includes one NRTI: the fixed-dose combination dolutegravir-lamivudine. Studies have found that initial therapy with dolutegravir-lamivudine has noninferior virologic efficacy as compared to standard three-drug initial therapy options, but dolutegravir-lamivudine is not recommended if the pretreatment viral load is above 500,000 copies/mL, if a person has hepatitis B (or unknown hepatitis B status), or if the baseline genotype resistance assay is pending (or results not known).

Monitoring Response to Antiretroviral Therapy

After initiating antiretroviral therapy, it is essential to monitor the virologic and immunologic response to therapy. The following outlines recommendations in the Adult and Adolescent ARV Guidelines for monitoring HIV RNA levels and CD4 cell counts in persons taking antiretroviral therapy.[\[74,75\]](#)

HIV RNA Monitoring

During the first 8 to 12 weeks after starting antiretroviral therapy, most individuals will achieve a reduction in HIV RNA levels to less than 50 copies/mL. For some individuals, particularly those with extremely high baseline HIV RNA levels, the time for virologic suppression may extend past 12 weeks. The important parameter is whether the HIV RNA levels continue to decline. In general, INSTI-based regimens cause a more rapid reduction in HIV RNA levels than NNRTI- or PI-based regimens.[\[76,77\]](#)

- **Baseline:** All individuals initiating antiretroviral therapy should have a baseline HIV RNA level.
- **After Initiating Therapy:** After starting antiretroviral therapy, an HIV RNA level should be obtained, preferably within 4 to 8 weeks. Subsequently, HIV RNA levels should be repeated every 4 to 8 weeks until the HIV RNA is suppressed to

Suboptimal CD4 Response to Antiretroviral Therapy

After starting antiretroviral therapy, virologic suppression is usually achieved by 3 to 6 months. The immunologic (CD4 cell) response is also important and is critical for determining the risk of opportunistic infections and other HIV-related complications. Typically, adults with HIV have a brisk increase in CD4 cells in the first 3 to 6 months after starting antiretroviral therapy, predominantly due to a release of memory CD4 cells trapped within lymphoid tissues.[80] In the second phase of CD4 recovery, there is a gradual increase in CD4 counts that continues for 3 to 6 years; this phase involves both naïve CD4 cells (from the thymus) and memory CD4 cells. In general, the baseline nadir CD4 cell count strongly predicts how high the CD4 count will rise to following years of antiretroviral therapy—essentially what level of CD4 count you start predicts what level you reach after years of antiretroviral treatment (Figure 18).[53,81,82] Approximately 15% of persons with HIV and advanced immunosuppression do not recover the CD4 count at a level greater than 200 cells/mm³ despite virologic suppression.[83,84]

Factors Associated with Suboptimal CD4 Recovery

Investigators have identified multiple factors associated with a suboptimal CD4 count response to antiretroviral therapy: older age, pretreatment CD4 count less than 200 cells/mm³, hepatitis C virus (HCV) coinfection, HIV type 2 (HIV-2) coinfection, coexistence of other chronic medical conditions, and the use of antiretroviral regimens that contain zidovudine, which is almost never prescribed in the current HIV treatment era.[28,85,86] Medications or chemotherapeutic agents that cause bone marrow suppression can significantly reduce the CD4 count, typically with a gradual return to normal after the medication is discontinued; these types of medications generally do not impact the CD4 percentage nearly as much as the absolute CD4 cell count.

Recommendations for Patients with Persistently Low CD4 Counts

For persons with HIV who have suboptimal CD4 count recovery (CD4 count remains below 200 cells/mm³ despite suppressed HIV RNA levels for at least 2 years), the Adult and Adolescent ARV Guidelines do not recommend intensifying or switching the antiretroviral regimen.[28] It is important to evaluate whether the individual is taking any medications (not used to treat HIV) that suppress the bone marrow or whether they have clinical manifestations (pancytopenia, systemic symptoms) that may suggest a bone marrow infiltrative process. In addition, individuals who have persistently low CD4 counts should receive appropriate prophylaxis for opportunistic infections, if indicated. Evaluation for tuberculosis and chronic viral hepatitis should be performed. Two large, randomized trials (ESPRIT and SILCATT) showed patients with suboptimal CD4 cell count responses who received interleukin-2 experienced significant increases in CD4 cell counts, but the increase was not associated with any clinical benefit, and it was not well tolerated.[87] Thus, the use of interleukin-2 to boost CD4 cell counts is not recommended.

Discontinuation or Treatment Interruption

Temporary discontinuation of antiretroviral therapy should be avoided whenever possible, but it may be necessary at times due to acute side effects, illness, surgery that prohibits oral intake, or unavailability of the antiretroviral medications. Planned treatment interruptions, often referred to as strategic treatment interruptions, were once thought to be potentially beneficial to limit long-term antiretroviral therapy toxicity. Subsequently, treatment interruptions were found to be detrimental to health outcomes.

Data Related to Strategic Treatment Interruptions

In the Strategies for Management of Antiretroviral Therapy (SMART) trial, investigators randomly assigned patients with CD4 counts greater than 350 cells/mm³ to either continuous or episodic use of antiretroviral therapy (the episodic group waited until the CD4 count decreased to 250 cells/mm³ to start, then stopped when the count reached 350 cells/mm³, and reinitiated therapy if the CD4 count declined to less than 250 cells/mm³).[\[88\]](#) The investigators found that the episodic therapy group had a significantly increased risk of opportunistic infection or death (from any cause) when compared with the continuous therapy group. In addition, the risk of major adverse cardiovascular events was higher for the group of participants who took antiretroviral therapy episodically, though the exact explanation for this increase was not confirmed.[\[89\]](#) Several other studies have shown that antiretroviral treatment interruption usually results in viral rebound, decreases in CD4 cell count, and, eventually, clinical progression.[\[90,91\]](#) Strategic treatment interruptions are not recommended.[\[92\]](#)

Recommendations

For patients who require short-term (temporary) discontinuation of antiretroviral therapy due to surgery or acute illness, or who make a planned interruption despite advice against interruption, the Adult and Adolescent ARV Guidelines provide specific recommendations for how to safely stop the medications, particularly for patients who are taking medications with significantly different half-lives.[\[92\]](#) In general, all medications should be stopped simultaneously and for the shortest duration possible. For individuals who cannot swallow oral pills (either temporarily or on a longer-term basis), resources are available to identify which antiretroviral agents can be administered as a liquid, crushed, or as a parenteral formulation. Specific recommendations for discontinuing long-acting, injectable antiretroviral medications, such as intramuscular cabotegravir-rilpivirine or lenacapavir, are also available in the package insert or guidelines.

Summary Points

- Six classes of antiretroviral medications, which target specific points of intervention in the multistep HIV life cycle, have been developed for clinical use: (1) entry inhibitors, (2) NRTIs, (3) NNRTIs, (4) INSTIs, (5) PIs, and (6) capsid inhibitors.
- Guidelines recommend initiation of antiretroviral therapy for all persons with HIV to reduce disease progression and prevent transmission; this recommendation reflects evidence from clinical trials and cohort studies that have shown the benefits of starting antiretroviral therapy early after acquiring HIV.
- The preferred initial antiretroviral regimens for most people with HIV, in the absence of receiving long-acting cabotegravir for HIV PrEP, consist of an INSTI anchor drug (bictegravir or dolutegravir) plus a 2-drug NRTI backbone. Other effective regimen options are available for use in certain clinical situations.
- If a person is diagnosed with HIV while or after receiving long-acting cabotegravir for PrEP, an integrase genotype is indicated and should be performed prior to initiating INSTI-based antiretroviral therapy. If antiretroviral therapy is initiated before integrase genotype results are available, a boosted darunavir-based regimen should be prescribed. The two-drug combination dolutegravir-lamivudine is also included as a preferred initial antiretroviral therapy option, but only if certain criteria are met.
- The choice of the initial antiretroviral regimen depends on multiple patient factors, including medical and mental health comorbidities, patient preferences, insurance coverage, drug interactions, and prior HIV PrEP usage.
- After the initiation of antiretroviral therapy, laboratory monitoring is important to determine the HIV RNA response to therapy, evaluate the CD4 count response, and to monitor for antiretroviral toxicity.
- Virologic response to antiretroviral therapy is the most important factor in predicting an overall successful treatment outcome, and most patients will achieve virologic suppression (HIV RNA below the lower level of detection of the assay) within 12 weeks.
- Typically, individuals with HIV have a brisk increase in CD4 cells in the first 3 to 6 months after starting antiretroviral therapy, followed by a more gradual increase over 3 to 6 years, although a small proportion of patients experience suboptimal CD4 cell count recovery despite sustained virologic suppression.

Citations

1. Rodger AJ, Cambiano V, Bruun T, et al. Sexual Activity Without Condoms and Risk of HIV Transmission in Serodifferent Couples When the HIV-Positive Partner Is Using Suppressive Antiretroviral Therapy. JAMA. 2016;316:171-81.
[\[PubMed Abstract\]](#) -
2. Kitahata MM, Gange SJ, Abraham AG, et al. Effect of early versus deferred antiretroviral therapy for HIV on survival. N Engl J Med. 2009;360:1815-26.
[\[PubMed Abstract\]](#) -
3. Bavinton BR, Pinto AN, Phanuphak N, et al. Viral suppression and HIV transmission in serodiscordant male couples: an international, prospective, observational, cohort study. Lancet HIV. 2018;5:e438-e447.
[\[PubMed Abstract\]](#) -
4. Arts EJ, Hazuda DJ. HIV-1 antiretroviral drug therapy. Cold Spring Harb Perspect Med. 2012;2:a007161.
[\[PubMed Abstract\]](#) -
5. Gandhi M, Gandhi RT. Single-pill combination regimens for treatment of HIV-1 infection. N Engl J Med. 2014;371:248-59.
[\[PubMed Abstract\]](#) -
6. Wilen CB, Tilton JC, Doms RW. HIV: cell binding and entry. Cold Spring Harb Perspect Med. 2012;2:a006866.
[\[PubMed Abstract\]](#) -
7. Schiller J, Chackerian B. Why HIV virions have low numbers of envelope spikes: implications for vaccine development. PLoS Pathog. 2014;10:e1004254.
[\[PubMed Abstract\]](#) -
8. Zhu P, Liu J, Bess J Jr, et al. Distribution and three-dimensional structure of AIDS virus envelope spikes. Nature. 2006;441:847-52.
[\[PubMed Abstract\]](#) -
9. Yi HA, Fochtman BC, Rizzo RC, Jacobs A. Inhibition of HIV Entry by Targeting the Envelope Transmembrane Subunit gp41. Curr HIV Res. 2016;14:283-94.
[\[PubMed Abstract\]](#) -
10. Chan DC, Fass D, Berger JM, Kim PS. Core structure of gp41 from the HIV envelope glycoprotein. Cell. 1997;89:263-73.
[\[PubMed Abstract\]](#) -
11. Montero M, van Houten NE, Wang X, Scott JK. The membrane-proximal external region of the human immunodeficiency virus type 1 envelope: dominant site of antibody neutralization and target for vaccine design. Microbiol Mol Biol Rev. 2008;72:54-84.
[\[PubMed Abstract\]](#) -
12. Klasse PJ. The molecular basis of HIV entry. Cell Microbiol. 2012;14:1183-92.
[\[PubMed Abstract\]](#) -
13. Pöhlmann S, Reeves JD. Cellular entry of HIV: Evaluation of therapeutic targets. Curr Pharm Des. 2006;12:1963-73.

[\[PubMed Abstract\]](#) -

14. Haqqani AA, Tilton JC. Entry inhibitors and their use in the treatment of HIV-1 infection. *Antiviral Res.* 2013;98:158-70.
[\[PubMed Abstract\]](#) -
15. Henrich TJ, Kuritzkes DR. HIV-1 entry inhibitors: recent development and clinical use. *Curr Opin Virol.* 2013;3:51-7.
[\[PubMed Abstract\]](#) -
16. Cahn P, Fink V, Patterson P. Fostemsavir: a new CD4 attachment inhibitor. *Curr Opin HIV AIDS.* 2018;13:341-345.
[\[PubMed Abstract\]](#) -
17. Kozal M, Aberg J, Pialoux G, et al. Fostemsavir in Adults with Multidrug-Resistant HIV-1 Infection. *N Engl J Med.* 2020;382:1232-43.
[\[PubMed Abstract\]](#) -
18. Bettiker RL, Koren DE, Jacobson JM. Ibalizumab. *Curr Opin HIV AIDS.* 2018;13:354-8.
[\[PubMed Abstract\]](#) -
19. Iacob SA, Iacob DG. Ibalizumab Targeting CD4 Receptors, An Emerging Molecule in HIV Therapy. *Front Microbiol.* 2017;8:2323.
[\[PubMed Abstract\]](#) -
20. Esté JA, Telenti A. HIV entry inhibitors. *Lancet.* 2007;370:81-8.
[\[PubMed Abstract\]](#) -
21. Kilby JM, Eron JJ. Novel therapies based on mechanisms of HIV-1 cell entry. *N Engl J Med.* 2003;348:2228-38.
[\[PubMed Abstract\]](#) -
22. Wilkin TJ, Gulick RM. CCR5 antagonism in HIV infection: current concepts and future opportunities. *Annu Rev Med.* 2012;63:81-93.
[\[PubMed Abstract\]](#) -
23. Panel on Antiretroviral Guidelines for Adults and Adolescents. Guidelines for the use of antiretroviral agents in adults and adolescents with HIV. Department of Health and Human Services. Laboratory testing: co-receptor tropism assays. October 25, 2018.
[\[HIV.gov\]](#) -
24. Tilton JC, Doms RW. Entry inhibitors in the treatment of HIV-1 infection. *Antiviral Res.* 2010;85:91-100.
[\[PubMed Abstract\]](#) -
25. Cervia JS, Smith MA. Enfuvirtide (T-20): a novel human immunodeficiency virus type 1 fusion inhibitor. *Clin Infect Dis.* 2003;37:1102-6.
[\[PubMed Abstract\]](#) -
26. Hu WS, Hughes SH. HIV-1 reverse transcription. *Cold Spring Harb Perspect Med.* 2012;2:a006882.
[\[PubMed Abstract\]](#) -
27. Sarafianos SG, Marchand B, Das K, et al. Structure and function of HIV-1 reverse transcriptase: molecular mechanisms of polymerization and inhibition. *J Mol Biol.* 2009;385:693-713.
[\[PubMed Abstract\]](#) -

28. Panel on Antiretroviral Guidelines for Adults and Adolescents. Guidelines for the use of antiretroviral agents in adults and adolescents with HIV. Department of Health and Human Services. Management of the treatment-experienced patient: suboptimal CD4 cell recovery despite viral suppression. September 25, 2025.
[\[HIV.gov\]](#) -
29. Deval J. Antimicrobial strategies: inhibition of viral polymerases by 3'-hydroxyl nucleosides. *Drugs*. 2009;69:151-66.
[\[PubMed Abstract\]](#) -
30. Sax PE, Pozniak A, Montes ML, et al. Coformulated bictegravir, emtricitabine, and tenofovir alafenamide versus dolutegravir with emtricitabine and tenofovir alafenamide, for initial treatment of HIV-1 infection (GS-US-380-1490): a randomised, double-blind, multicentre, phase 3, non-inferiority trial. *Lancet*. 2017;390:2073-82.
[\[PubMed Abstract\]](#) -
31. Vandegraaff N, Engelman A. Molecular mechanisms of HIV integration and therapeutic intervention. *Expert Rev Mol Med*. 2007;9:1-19.
[\[PubMed Abstract\]](#) -
32. Raheem IT, Girijavallabhan V, Fillgrove KL, et al. MK-8527 is a novel inhibitor of HIV-1 reverse transcriptase translocation with potential for extended-duration dosing. *PLoS Biol*. 2025;23:e3003308.
[\[PubMed Abstract\]](#) -
33. Salie ZL, Kirby KA, Michailidis E, et al. Structural basis of HIV inhibition by translocation-defective RT inhibitor 4'-ethynyl-2'-fluoro-2'-deoxyadenosine (EFdA). *Proc Natl Acad Sci U S A*. 2016;113:9274-9.
[\[PubMed Abstract\]](#) -
34. Schauer G, Leuba S, Sluis-Cremer N. Biophysical Insights into the Inhibitory Mechanism of Non-Nucleoside HIV-1 Reverse Transcriptase Inhibitors. *Biomolecules*. 2013;3:889-904.
[\[PubMed Abstract\]](#) -
35. Clavel F, Hance AJ. HIV drug resistance. *N Engl J Med*. 2004;350:1023-35.
[\[PubMed Abstract\]](#) -
36. Singh K, Marchand B, Kirby KA, Michailidis E, Sarafianos SG. Structural Aspects of Drug Resistance and Inhibition of HIV-1 Reverse Transcriptase. *Viruses*. 2010;2:606-638.
[\[PubMed Abstract\]](#) -
37. Craigie R. HIV integrase, a brief overview from chemistry to therapeutics. *J Biol Chem*. 2001;276:23213-6.
[\[PubMed Abstract\]](#) -
38. Engelman A, Cherepanov P. Retroviral Integrase Structure and DNA Recombination Mechanism. *Microbiol Spectr*. 2014;2(6).
[\[PubMed Abstract\]](#) -
39. Pommier Y, Johnson AA, Marchand C. Integrase inhibitors to treat HIV/AIDS. *Nat Rev Drug Discov*. 2005;4:236-48.
[\[PubMed Abstract\]](#) -
40. Lataillade M, Kozal MJ. The hunt for HIV-1 integrase inhibitors. *AIDS Patient Care STDS*. 2006;20:489-501.

[\[PubMed Abstract\]](#) -

41. Grandgenett DP, Pandey KK, Bera S, Aihara H. Multifunctional facets of retrovirus integrase. *World J Biol Chem.* 2015;6:83-94.
[\[PubMed Abstract\]](#) -
42. Ingale KB, Bhatia MS. HIV-1 integrase inhibitors: a review of their chemical development. *Antivir Chem Chemother.* 2011;22:95-105.
[\[PubMed Abstract\]](#) -
43. Hazuda DJ. HIV integrase as a target for antiretroviral therapy. *Curr Opin HIV AIDS.* 2012;7:383-9.
[\[PubMed Abstract\]](#) -
44. Flexner C. HIV-protease inhibitors. *N Engl J Med.* 1998;338:1281-92.
[\[PubMed Abstract\]](#) -
45. Adamson CS. Protease-Mediated Maturation of HIV: Inhibitors of Protease and the Maturation Process. *Mol Biol Int.* 2012;2012:604261.
[\[PubMed Abstract\]](#) -
46. Briggs JA, Simon MN, Gross I, et al. The stoichiometry of Gag protein in HIV-1. *Nat Struct Mol Biol.* 2004;11:672-5.
[\[PubMed Abstract\]](#) -
47. Adamson CS, Jones IM. The molecular basis of HIV capsid assembly--five years of progress. *Rev Med Virol.* 2004;14:107-21.
[\[PubMed Abstract\]](#) -
48. Freed EO. HIV-1 assembly, release and maturation. *Nat Rev Microbiol.* 2015;13:484-96.
[\[PubMed Abstract\]](#) -
49. Aiken C, Rousso I. The HIV-1 capsid and reverse transcription. *Retrovirology.* 2021;18:29.
[\[PubMed Abstract\]](#) -
50. Bester SM, Adu-Ampratwum D, Annamalai AS, et al. Structural and Mechanistic Bases of Viral Resistance to HIV-1 Capsid Inhibitor Lenacapavir. *mBio.* 2022;13:e0180422.
[\[PubMed Abstract\]](#) -
51. AlBurtamani N, Paul A, Fassati A. The Role of Capsid in the Early Steps of HIV-1 Infection: New Insights into the Core of the Matter. *Viruses.* 2021;13:1161.
[\[PubMed Abstract\]](#) -
52. Bester SM, Wei G, Zhao H, et al. Structural and mechanistic bases for a potent HIV-1 capsid inhibitor. *Science.* 2020;370:360-4.
[\[PubMed Abstract\]](#) -
53. Gras L, Kesselring AM, Griffin JT, et al. CD4 cell counts of 800 cells/mm³ or greater after 7 years of highly active antiretroviral therapy are feasible in most patients starting with 350 cells/mm³ or greater. *J Acquir Immune Defic Syndr.* 2007;45:183-92.
[\[PubMed Abstract\]](#) -
54. McFadden WM, Snyder AA, Kirby KA, et al. Rotten to the core: antivirals targeting the HIV-1 capsid core. *Retrovirology.* 2021;18:41.
[\[PubMed Abstract\]](#) -

55. Selyutina A, Hu P, Miller S, et al. GS-CA1 and lenacapavir stabilize the HIV-1 core and modulate the core interaction with cellular factors. *iScience*. 2022 ;25:103593.
[\[PubMed Abstract\]](#) -
56. Panel on Antiretroviral Guidelines for Adults and Adolescents. Guidelines for the use of antiretroviral agents in adults and adolescents with HIV. Department of Health and Human Services. Initiation of antiretroviral therapy. September 25, 2025.
[\[HIV.gov\]](#) -
57. Sterling TR, Chaisson RE, Keruly J, Moore RD. Improved outcomes with earlier initiation of highly active antiretroviral therapy among human immunodeficiency virus-infected patients who achieve durable virologic suppression: longer follow-up of an observational cohort study. *J Infect Dis*. 2003;188:1659-65.
[\[PubMed Abstract\]](#) -
58. Sterne JA, May M, Costagliola D, et al. Timing of initiation of antiretroviral therapy in AIDS-free HIV-1-infected patients: a collaborative analysis of 18 HIV cohort studies. *Lancet*. 2009;373:1352-63.
[\[PubMed Abstract\]](#) -
59. Severe P, Juste MA, Ambroise A, et al. Early versus standard antiretroviral therapy for HIV-infected adults in Haiti. *N Engl J Med*. 2010;363:257-65.
[\[PubMed Abstract\]](#) -
60. INSIGHT START Study Group, Lundgren JD, Babiker AG, Gordin F, et al. Initiation of Antiretroviral Therapy in Early Asymptomatic HIV Infection. *N Engl J Med*. 2015;373:795-807.
[\[PubMed Abstract\]](#) -
61. Opravil M, Ledergerber B, Furrer H, et al. Clinical efficacy of early initiation of HAART in patients with asymptomatic HIV infection and CD4 cell count > 350 x 10⁶/l. *AIDS*. 2002;16:1371-81.
[\[PubMed Abstract\]](#) -
62. Connor EM, Sperling RS, Gelber R, et al. Reduction of maternal-infant transmission of human immunodeficiency virus type 1 with zidovudine treatment. Pediatric AIDS Clinical Trials Group Protocol 076 Study Group. *N Engl J Med*. 1994;331:1173-80.
[\[PubMed Abstract\]](#) -
63. Rodger AJ, Cambiano V, Bruun T, et al. Risk of HIV transmission through condomless sex in serodifferent gay couples with the HIV-positive partner taking suppressive antiretroviral therapy (PARTNER): final results of a multicentre, prospective, observational study. *Lancet*. 2019;393:2428-38.
[\[PubMed Abstract\]](#) -
64. Gonzalo-Gil E, Ikediobi U, Sutton RE. Mechanisms of Virologic Control and Clinical Characteristics of HIV+ Elite/Viremic Controllers. *Yale J Biol Med*. 2017;90:245-259.
[\[PubMed Abstract\]](#) -
65. Okulicz JF, Marconi VC, Landrum ML, et al. Clinical outcomes of elite controllers, viremic controllers, and long-term nonprogressors in the US Department of Defense HIV natural history study. *J Infect Dis*. 2009;200:1714-23.
[\[PubMed Abstract\]](#) -
66. Grabar S, Selinger-Leneman H, Abgrall S, Pialoux G, Weiss L, Costagliola D. Loss of long-term non-progressor and HIV controller status over time in the French Hospital Database on HIV - ANRS CO4. *PLoS One*. 2017;12:e0184441.

[\[PubMed Abstract\]](#) -

67. Pereyra F, Lo J, Triant VA, et al. Increased coronary atherosclerosis and immune activation in HIV-1 elite controllers. *AIDS*. 2012;26:2409-12.
[\[PubMed Abstract\]](#) -
68. Panel on Antiretroviral Guidelines for Adults and Adolescents. Guidelines for the Use of Antiretroviral Agents in Adults and Adolescents with HIV. Department of Health and Human Services. What to Start. Initial Combination Antiretroviral Regimens for People With HIV. September 12, 2024.
[\[HIV.gov\]](#) -
69. Panel on Antiretroviral Guidelines for Adults and Adolescents. Guidelines for the use of antiretroviral agents in adults and adolescents with HIV. Department of Health and Human Services. Considerations for antiretroviral use in special patient populations: Women with HIV. September 12, 2024.
[\[HIV.gov\]](#) -
70. Panel on Treatment of HIV During Pregnancy and Prevention of Perinatal Transmission. Recommendations for the Use of Antiretroviral Drugs During Pregnancy and Interventions to Reduce Perinatal HIV Transmission in the United States. Antepartum Care. Recommendations for use of antiretroviral drugs during pregnancy. Recommendations for Use of Antiretroviral Drugs During Pregnancy. Table 7. Situation-Specific Recommendations for Use of Antiretroviral Drugs During Pregnancy and When Trying to Conceive. March 31, 2026.
[\[HIV.gov\]](#) -
71. Panel on Treatment of HIV During Pregnancy and Prevention of Perinatal Transmission. Recommendations for the Use of Antiretroviral Drugs During Pregnancy and Interventions to Reduce Perinatal HIV Transmission in the United States. Antepartum Care. Recommendations for Use of Antiretroviral Drugs During Pregnancy. Table 6. What to Start: Initial Antiretroviral Regimens During Pregnancy. March 31, 2026.
[\[HIV.gov\]](#) -
72. Panel on Antiretroviral Guidelines for Adults and Adolescents. Guidelines for the use of antiretroviral agents in adults and adolescents with HIV. Department of Health and Human Services. What to start: Table 7. Antiretroviral Regimen Considerations for Initial Therapy Based on Specific Clinical Scenarios. September 12, 2024.
[\[HIV.gov\]](#) -
73. Panel on Antiretroviral Guidelines for Adults and Adolescents. Guidelines for the use of antiretroviral agents in adults and adolescents with HIV. Department of Health and Human Services. Laboratory testing: laboratory testing for initial assessment and monitoring of people with HIV. September 25, 2025.
[\[HIV.gov\]](#) -
74. Panel on Antiretroviral Guidelines for Adults and Adolescents. Guidelines for the use of antiretroviral agents in adults and adolescents with HIV. Department of Health and Human Services. Laboratory testing: plasma HIV-1 RNA (viral load) and CD4 count monitoring. September 25, 2025.
[\[HIV.gov\]](#) -
75. Clotet B, Feinberg J, van Lunzen J, et al. Once-daily dolutegravir versus darunavir plus ritonavir in antiretroviral-naïve adults with HIV-1 infection (FLAMINGO): 48 week results from the randomised open-label phase 3b study. *Lancet*. 2014;383:2222-31.
[\[PubMed Abstract\]](#) -
76. Lennox JL, Dejesus E, Lazzarin A, et al. Safety and efficacy of raltegravir-based versus efavirenz-based

combination therapy in treatment-naive patients with HIV-1 infection: a multicentre, double-blind randomised controlled trial. *Lancet*. 2009;374(9692):796-806.

[\[PubMed Abstract\]](#) -

77. Moore RD, Keruly JC. CD4+ cell count 6 years after commencement of highly active antiretroviral therapy in persons with sustained virologic suppression. *Clin Infect Dis*. 2007;44:441-6.
[\[PubMed Abstract\]](#) -
78. Kaufmann GR, Perrin L, Pantaleo G, et al. CD4 T-lymphocyte recovery in individuals with advanced HIV-1 infection receiving potent antiretroviral therapy for 4 years: the Swiss HIV Cohort Study. *Arch Intern Med*. 2003;163:2187-95.
[\[PubMed Abstract\]](#) -
79. Battegay M, Nüesch R, Hirschel B, Kaufmann GR. Immunological recovery and antiretroviral therapy in HIV-1 infection. *Lancet Infect Dis*. 2006;6:280-7.
[\[PubMed Abstract\]](#) -
80. Kelley CF, Kitchen CM, Hunt PW, Rodriguez B, Hecht FM, Kitahata M, Crane HM, Willig J, Mugavero M, Saag M, Martin JN, Deeks SG. Incomplete peripheral CD4+ cell count restoration in HIV-infected patients receiving long-term antiretroviral treatment. *Clin Infect Dis*. 2009;48:787-94.
[\[PubMed Abstract\]](#) -
81. Luz PM, Grinsztejn B, Velasque L, et al. Long-term CD4+ cell count in response to combination antiretroviral therapy. *PLoS One*. 2014;9:e93039.
[\[PubMed Abstract\]](#) -
82. Egger M, Hirschel B, Francioli P, et al. Impact of new antiretroviral combination therapies in HIV infected patients in Switzerland: prospective multicentre study. *Swiss HIV Cohort Study*. *BMJ*. 1997;315:1194-9.
[\[PubMed Abstract\]](#) -
83. Zoufaly A, an der Heiden M, Kollan C, Bogner JR, et al. Clinical outcome of HIV-infected patients with discordant virological and immunological response to antiretroviral therapy. *J Infect Dis*. 2011;203:364-71.
[\[PubMed Abstract\]](#) -
84. Karrer U, Ledergerber B, Furrer H, et al. Dose-dependent influence of didanosine on immune recovery in HIV-infected patients treated with tenofovir. *AIDS*. 2005;19:1987-94.
[\[PubMed Abstract\]](#) -
85. Bartlett JA, Fath MJ, Demasi R, Hermes A, Quinn J, Mondou E, Rousseau F. An updated systematic overview of triple combination therapy in antiretroviral-naive HIV-infected adults. *AIDS*. 2006;20:2051-64.
[\[PubMed Abstract\]](#) -
86. INSIGHT-ESPRIT Study Group; SILCAAT Scientific Committee, Abrams D, et al. Interleukin-2 therapy in patients with HIV infection. *N Engl J Med*. 2009;361:1548-59.
[\[PubMed Abstract\]](#) -
87. Strategies for Management of Antiretroviral Therapy (SMART) Study Group, El-Sadr WM, Lundgren JD, et al. CD4+ count-guided interruption of antiretroviral treatment. *N Engl J Med*. 2006;355:2283-96.
[\[PubMed Abstract\]](#) -
88. Phillips AN, Carr A, Neuhaus J, et al. Interruption of antiretroviral therapy and risk of cardiovascular

disease in persons with HIV-1 infection: exploratory analyses from the SMART trial. *Antivir Ther.* 2008;13:177-87.

[\[PubMed Abstract\]](#) -

89. Holkmann Olsen C, Mocroft A, Kirk O, et al. Interruption of combination antiretroviral therapy and risk of clinical disease progression to AIDS or death. *HIV Med.* 2007;8:96-104.

[\[PubMed Abstract\]](#) -

90. Kousignian I, Abgrall S, Grabar S, et al. Maintaining antiretroviral therapy reduces the risk of AIDS-defining events in patients with uncontrolled viral replication and profound immunodeficiency. *Clin Infect Dis.* 2008;46:296-304.

[\[PubMed Abstract\]](#) -

91. Panel on Antiretroviral Guidelines for Adults and Adolescents. Guidelines for the use of antiretroviral agents in adults and adolescents with HIV. Department of Health and Human Services. Management of the treatment-experienced patient. Discontinuation or interruption of antiretroviral therapy. January 20, 2022.

[\[HIV.gov\]](#) -

References

- Cahn P, Madero JS, Arribas JR, et al. Dolutegravir plus lamivudine versus dolutegravir plus tenofovir disoproxil fumarate and emtricitabine in antiretroviral-naïve adults with HIV-1 infection (GEMINI-1 and GEMINI-2): week 48 results from two multicentre, double-blind, randomised, non-inferiority, phase 3 trials. *Lancet.* 2019;393:143-55.
[\[PubMed Abstract\]](#) -
- Cohen CJ, Andrade-Villanueva J, et al. Rilpivirine versus efavirenz with two background nucleoside or nucleotide reverse transcriptase inhibitors in treatment-naïve adults infected with HIV-1 (THRIVE): a phase 3, randomised, non-inferiority trial. *Lancet.* 2011;378:229-37.
[\[PubMed Abstract\]](#) -
- Cohen MS, Chen YQ, McCauley M, et al. Prevention of HIV-1 infection with early antiretroviral therapy. *N Engl J Med.* 2011;365:493-505.
[\[PubMed Abstract\]](#) -
- Markowitz M, Sarafianos SG. 4'-Ethylnyl-2-fluoro-2'-deoxyadenosine, MK-8591: a novel HIV-1 reverse transcriptase translocation inhibitor. *Curr Opin HIV AIDS.* 2018;13:294-9.
[\[PubMed Abstract\]](#) -
- McNairy ML, El-Sadr WM. Antiretroviral therapy for the prevention of HIV transmission: what will it take? *Clin Infect Dis.* 2014;58:1003-11.
[\[PubMed Abstract\]](#) -
- Mocroft A, Phillips AN, Gatell J, et al. Normalisation of CD4 counts in patients with HIV-1 infection and maximum virological suppression who are taking combination antiretroviral therapy: an observational cohort study. *Lancet.* 2007;370:407-13.
[\[PubMed Abstract\]](#) -
- Pulido F, Ribera E, Lagarde M, et al. Dual Therapy With Darunavir and Ritonavir Plus Lamivudine vs Triple Therapy With Darunavir and Ritonavir Plus Tenofovir Disoproxil Fumarate and Emtricitabine or Abacavir and Lamivudine for Maintenance of Human Immunodeficiency Virus Type 1 Viral Suppression: Randomized, Open-Label, Noninferiority DUAL-GESIDA 8014-RIS-EST45 Trial. *Clin Infect*

Dis. 2017;65:2112-8.

[\[PubMed Abstract\]](#) -

- Samji H, Cescon A, Hogg RS, et al. Closing the gap: increases in life expectancy among treated HIV-positive individuals in the United States and Canada. PLoS One. 2013;8:e81355.
[\[PubMed Abstract\]](#) -
- Sluis-Cremer N, Tachedjian G. Mechanisms of inhibition of HIV replication by non-nucleoside reverse transcriptase inhibitors. Virus Res. 2008;134:147-56.
[\[PubMed Abstract\]](#) -
- Strategies for Management of Antiretroviral Therapy (SMART) Study Group, Emery S, Neuhaus JA, et al. Major clinical outcomes in antiretroviral therapy (ART)-naive participants and in those not receiving ART at baseline in the SMART study. J Infect Dis. 2008;197:1133-44.
[\[PubMed Abstract\]](#) -
- Tronchet JM, Seman M. Nonnucleoside inhibitors of HIV-1 reverse transcriptase: from the biology of reverse transcription to molecular design. Curr Top Med Chem. 2003;3:1496-511.
[\[PubMed Abstract\]](#) -

Figures

Figure 1 HIV Life Cycle and Site of Inhibitors of Viral Replication

Illustration: Cognition Studio, Inc. and David H. Spach, MD

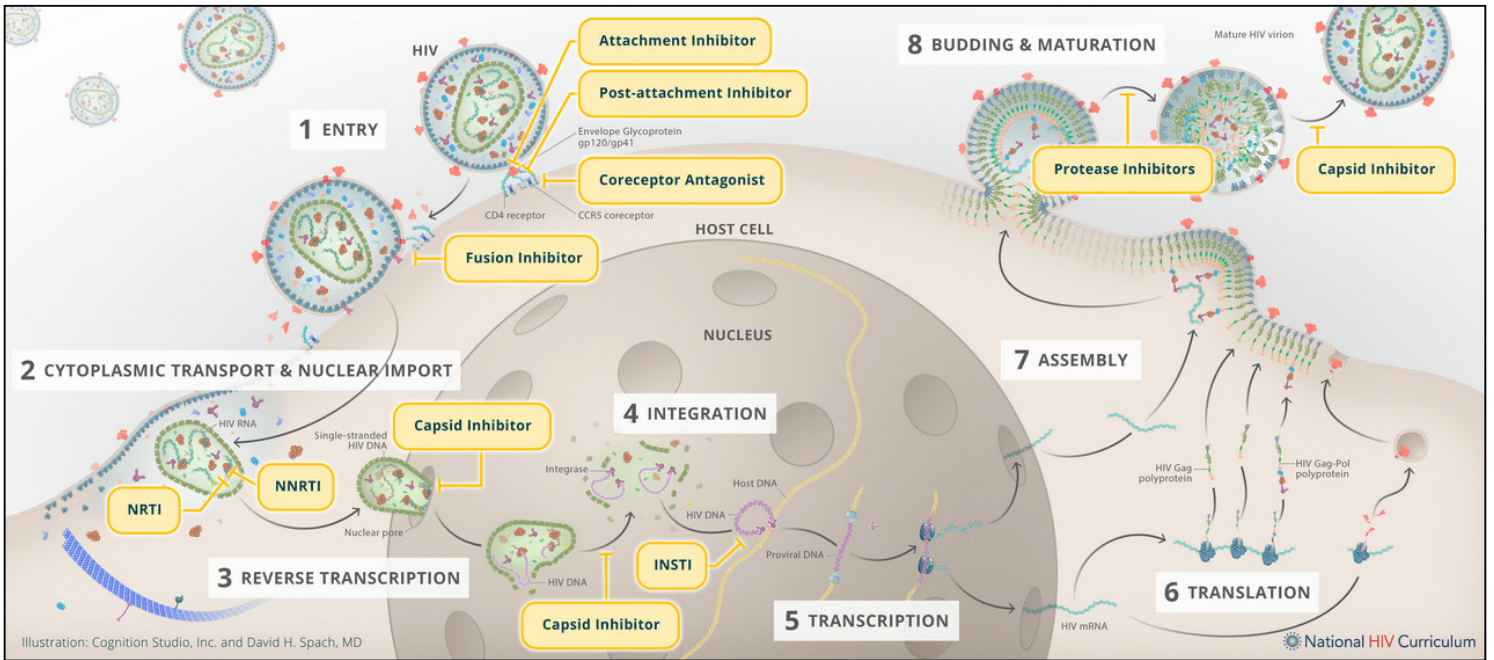

**Figure 2 (Image Series) - HIV Envelope (Image Series) - Figure 2 (Image Series) - HIV Envelope
Image 2A: HIV Envelope Proteins on HIV Surface**

Each HIV has approximately 14 irregularly spaced envelope glycoprotein spikes on the surface of HIV.

Illustration: Cognition Studio, Inc. and David Spach, MD

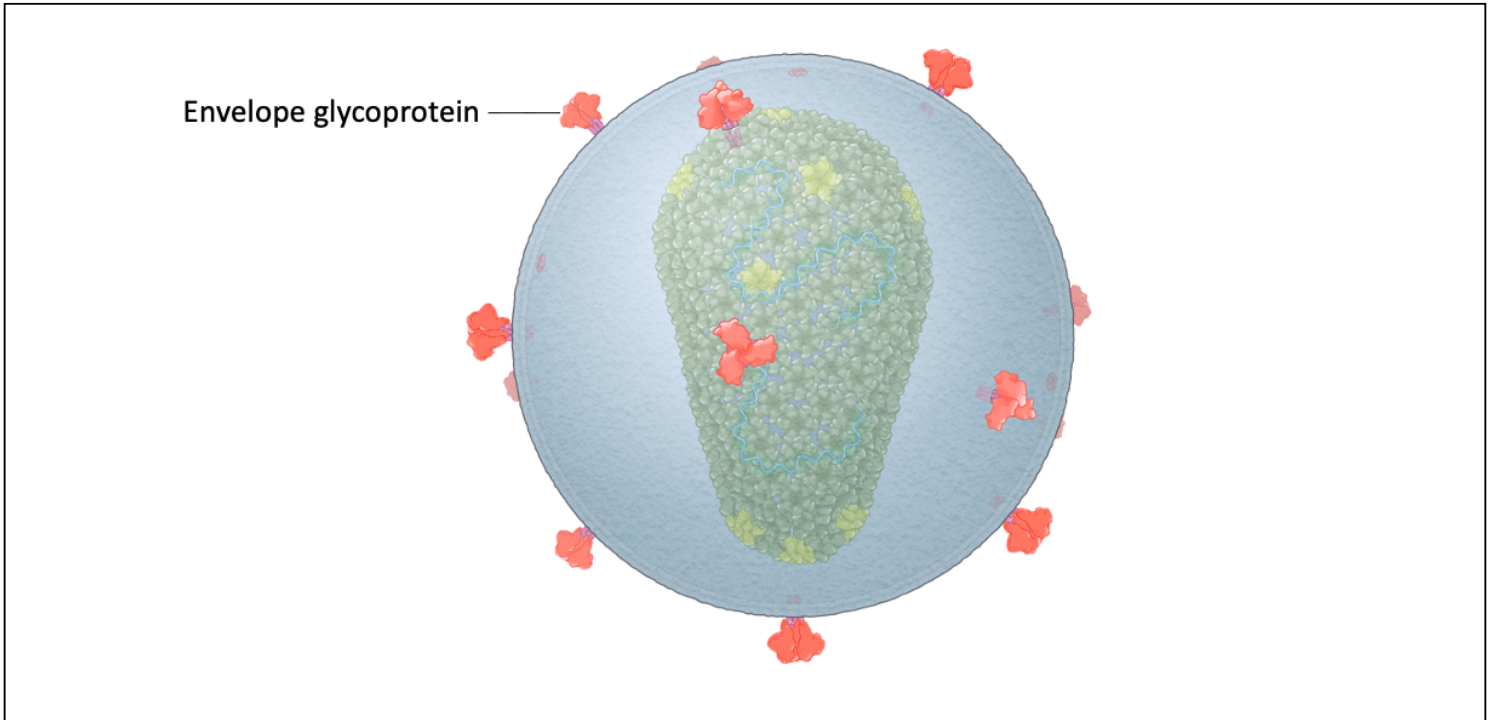

Figure 2 (Image Series) - HIV Envelope
Image 2B: gp120 and gp41

Illustration: Cognition Studio, Inc. and David Spach, MD

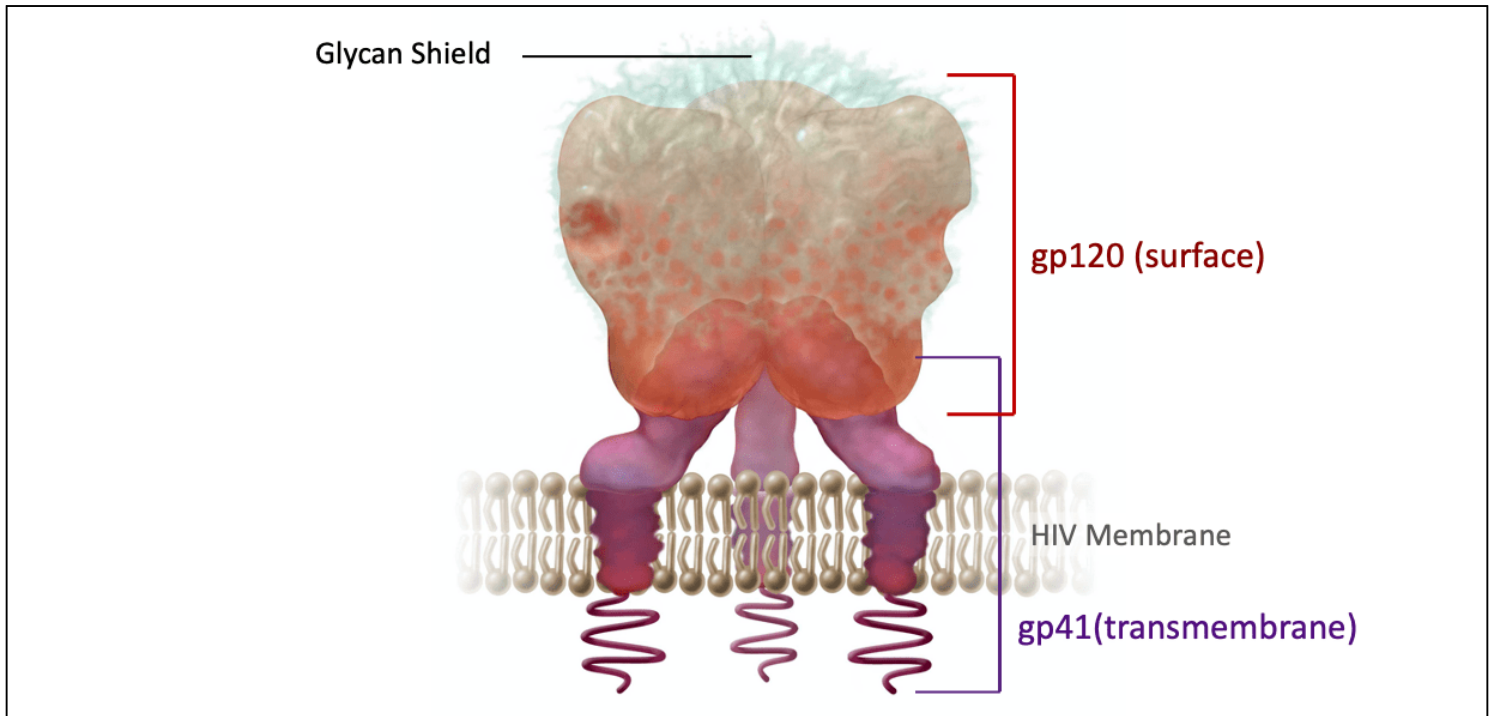

Figure 3 gp120 and gp41

Each HIV envelope spike is a trimeric structure, with each trimer comprised of gp120 subunits paired with gp41 subunits. The trimer of heterodimers is arranged in a tripod-like conformation. The gp120 is coated with an immunoprotective glycan shield that helps HIV evade the host immune system.

Illustration: Cognition Studio, Inc. and David Spach, MD

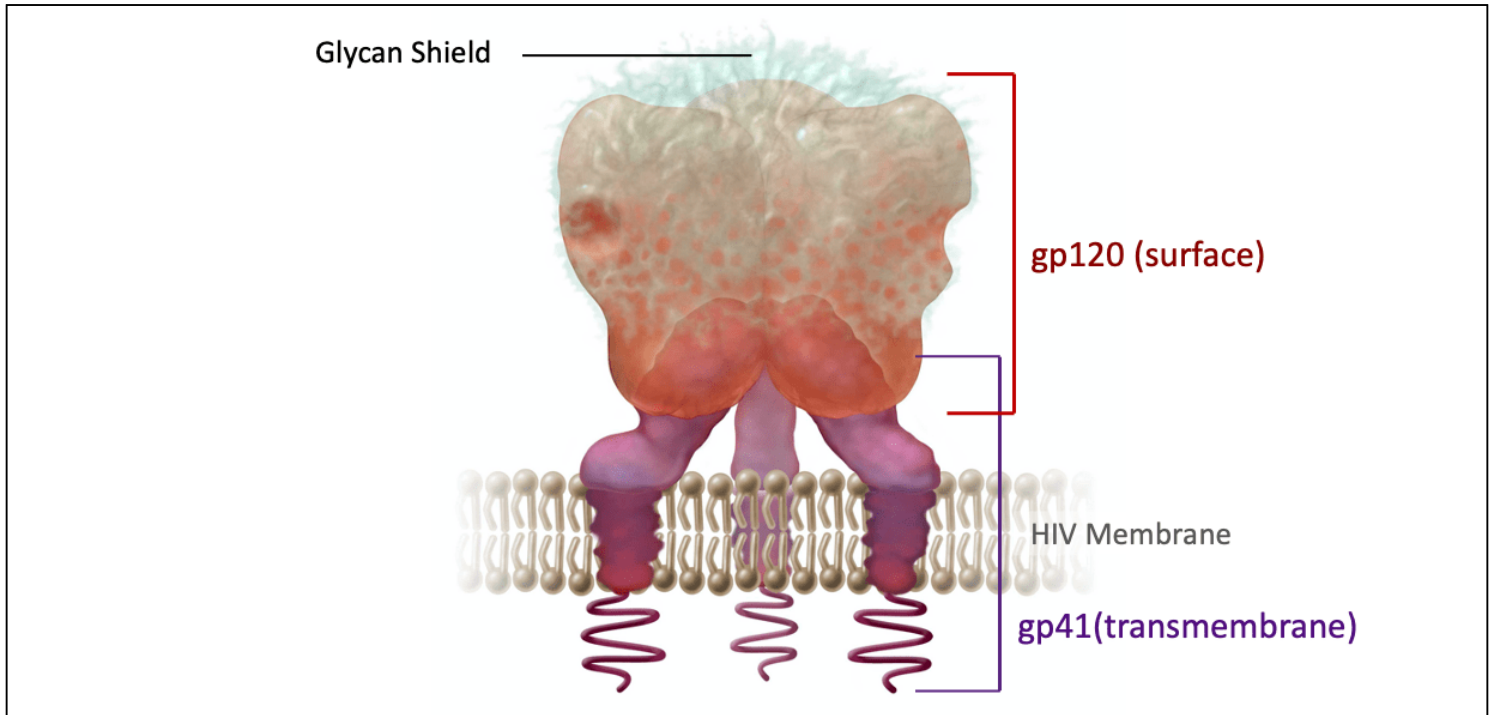

Figure 4 (Image Series) - HIV Tropism and Binding to Host Coreceptors (Image Series) - Figure 4 (Image Series) - HIV Tropism and Binding to Host Coreceptors

Image 4A: R5-Tropic HIV

In this illustration, R5-tropic HIV is represented by the blue envelope spikes; the R5 HIV binds to the host CCR5 coreceptor during the viral cell entry process.

Illustration: David Spach, MD

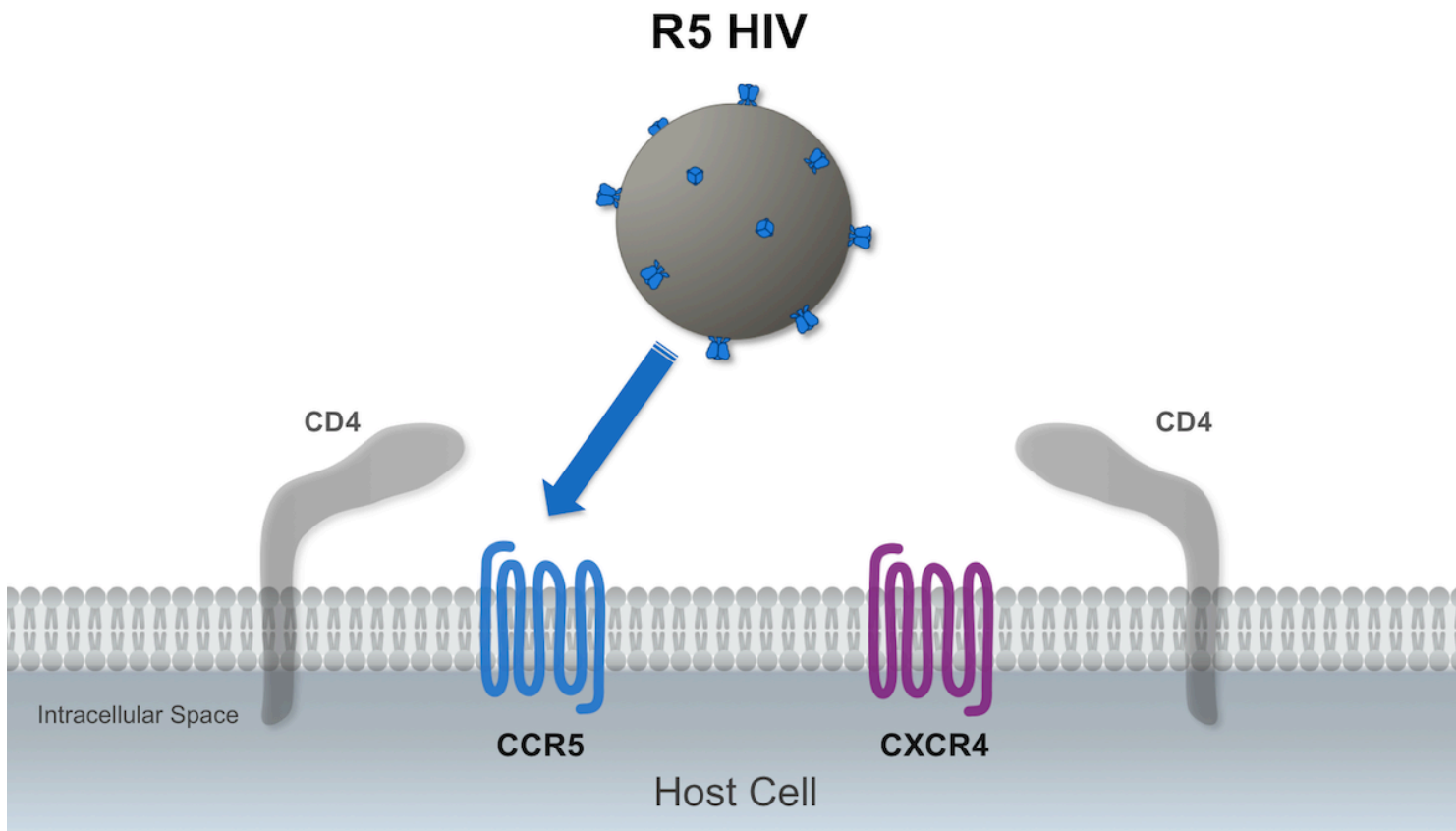

Figure 4 (Image Series) - HIV Tropism and Binding to Host Coreceptors
Image 4B: X4-Tropic HIV

In this illustration, X4-tropic HIV is represented by the purple envelope spikes; the X4 HIV binds to the host CCR5 coreceptor during the viral cell entry process.

Illustration: David Spach, MD

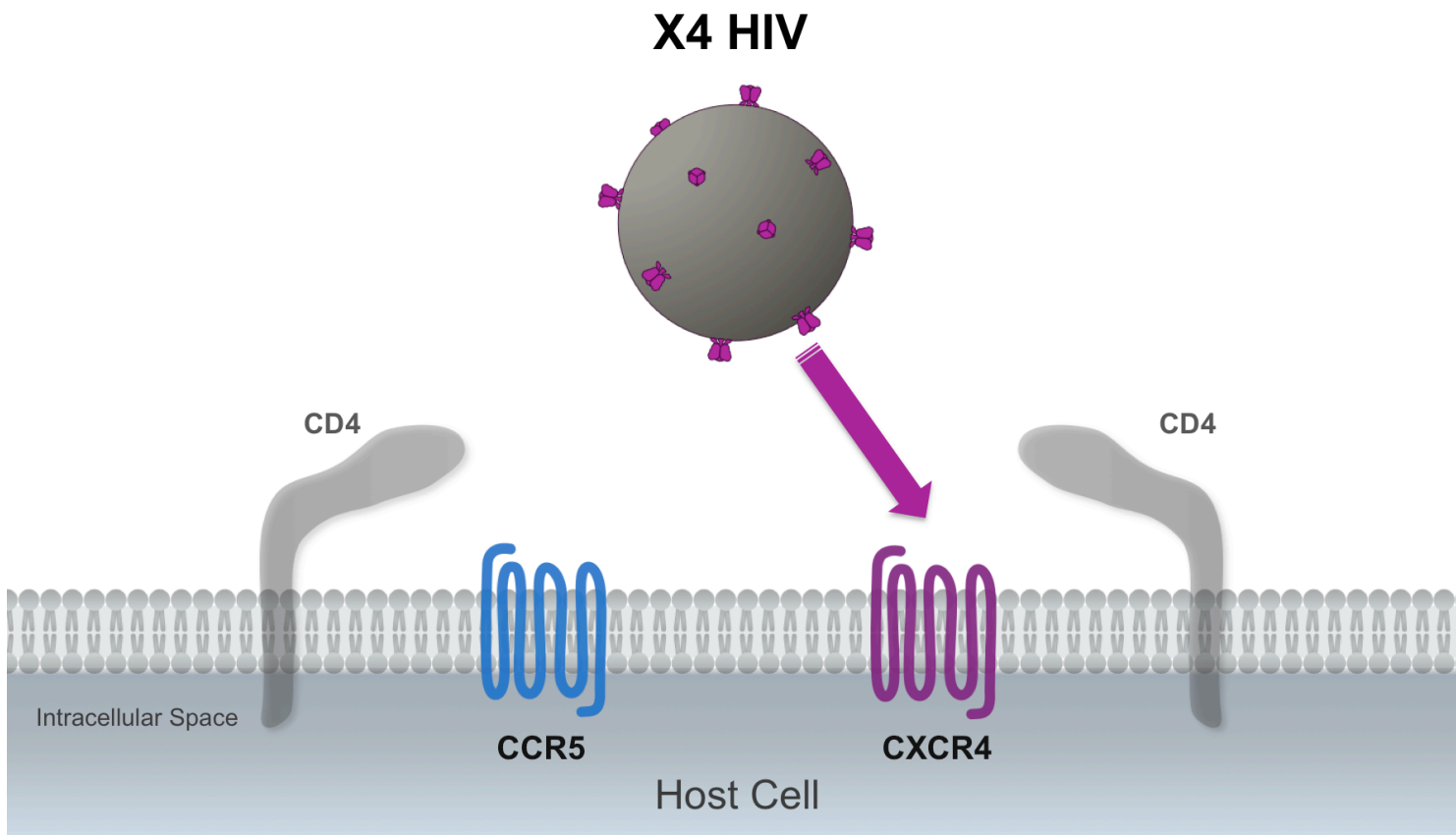

Figure 4 (Image Series) - HIV Tropism and Binding to Host Coreceptors
Image 4C: Dual-Tropic HIV

In this illustration, dual-tropic HIV is represented by both blue and purple envelope spikes; the dual-tropic HIV can bind to the host CCR5 or CXCR4 coreceptors during the viral cell entry process.

Illustration: David Spach, MD

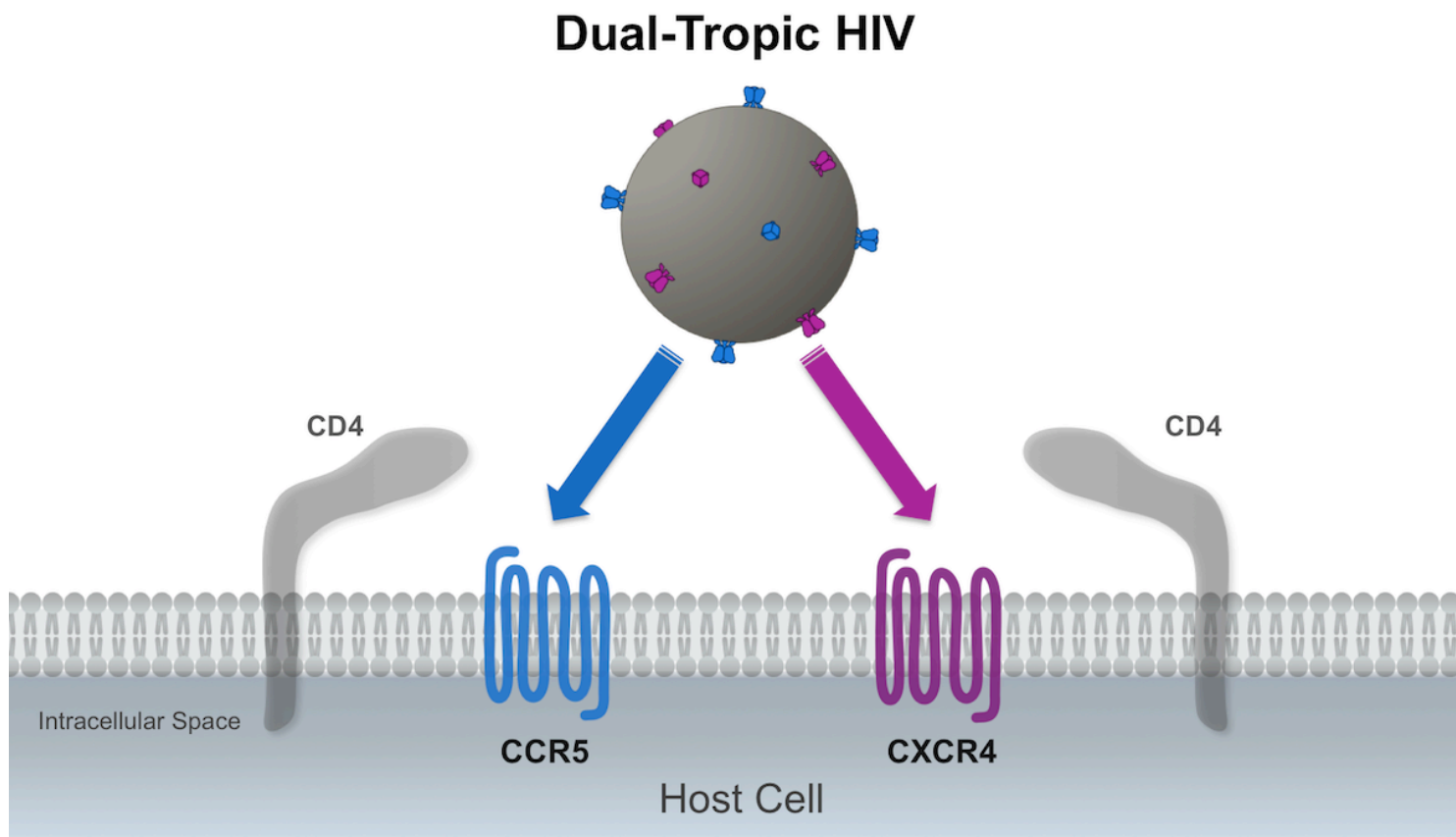

Figure 4 (Image Series) - HIV Tropism and Binding to Host Coreceptors
Image 4D: Mixed-Tropic HIV

In this illustration, mixed-tropic HIV is represented by a mixture of R5-tropic HIV (blue envelope spikes) and X4-tropic HIV (purple envelope spikes); the R5 HIV binds to the CCR5 coreceptor and the X4 HIV binds to the CXCR4 coreceptor.

Illustration: David Spach, MD

Mixed-Tropic HIV

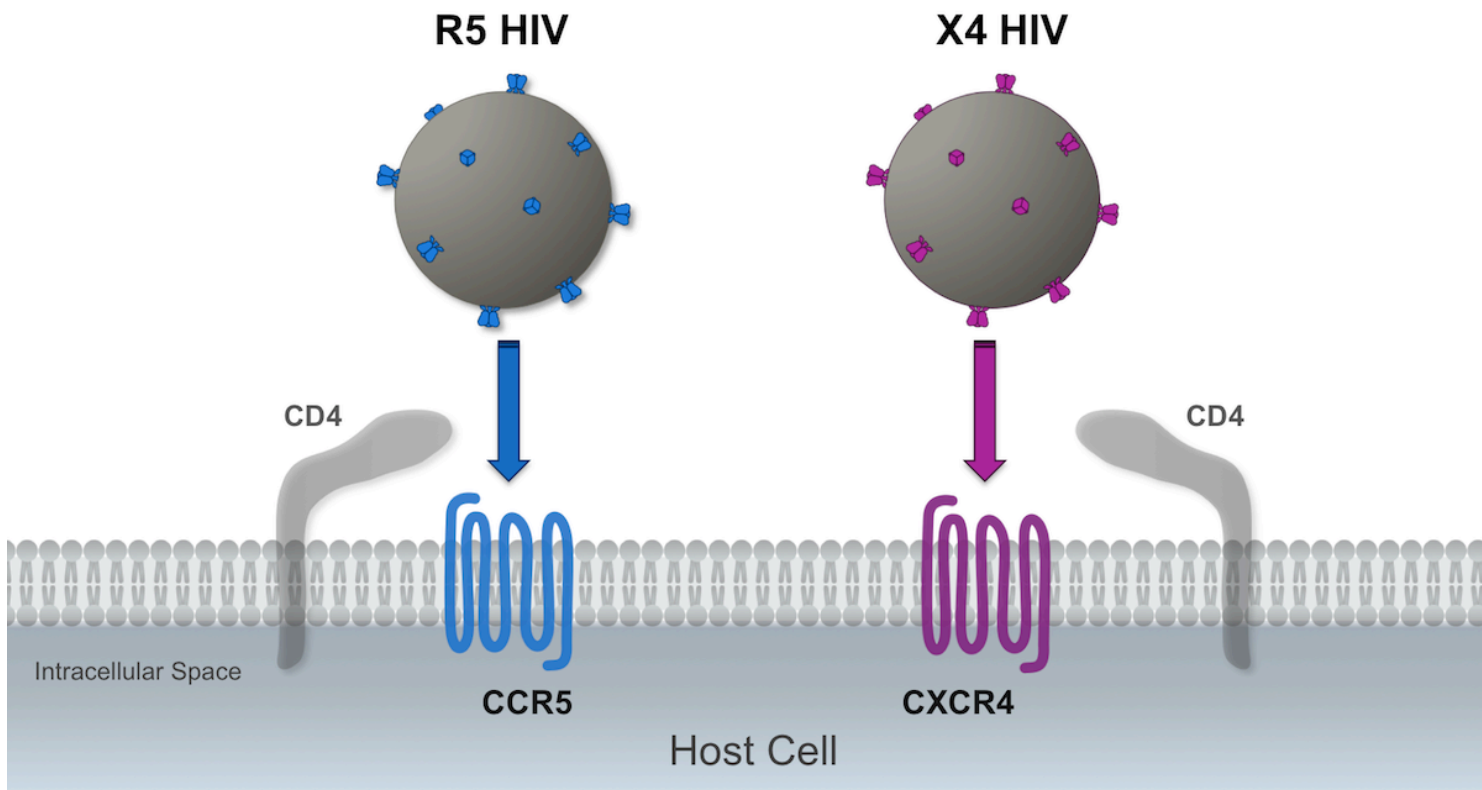

Figure 5 (Image Series) - Mechanism of Action of Entry Inhibitors (Image Series) - Figure 5 (Image Series) - Mechanism of Action of Entry Inhibitors
Image 5A: Mechanism of Action of Attachment Inhibitors: Fostemsavir

The attachment inhibitor fostemsavir is hydrolyzed to its active form temsavir, which binds to HIV gp120 and prevents attachment between HIV gp120 and the host cell CD4 receptor.

Illustration: Cognition Studio, Inc. and David H. Spach, MD

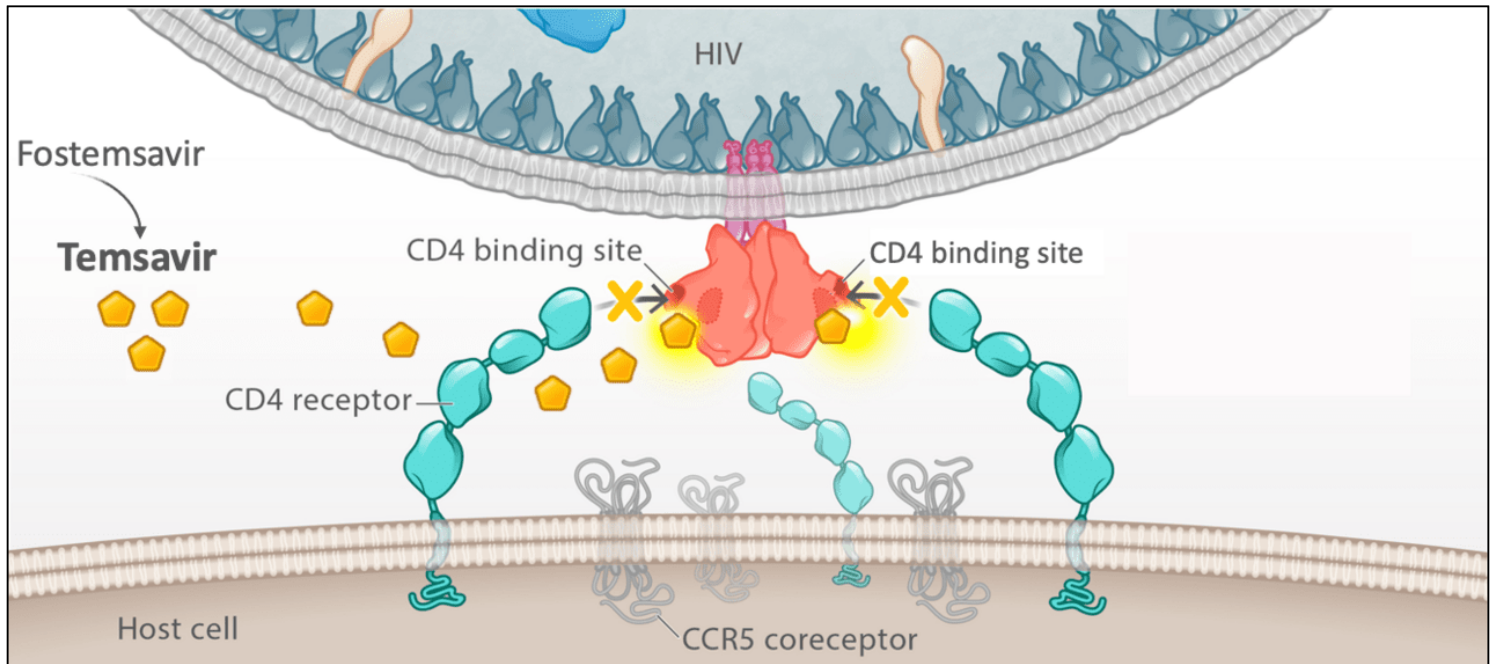

Figure 5 (Image Series) - Mechanism of Action of Entry Inhibitors
Image 5B: Mechanism of Action of CD4 Postattachment Inhibitors: Ibalizumab

The CD4 postattachment inhibitor ibalizumab is a humanized monoclonal antibody that binds to the domain 2 region of the human CD4 cell receptor. This binding does not prevent attachment of HIV gp120 with the host CD4 receptor, but, through steric hindrance, it prevents normal postbinding conformational changes in HIV gp120 that are required for gp120-host cell coreceptor binding.

Illustration: Cognition Studio, Inc. and David H. Spach, MD

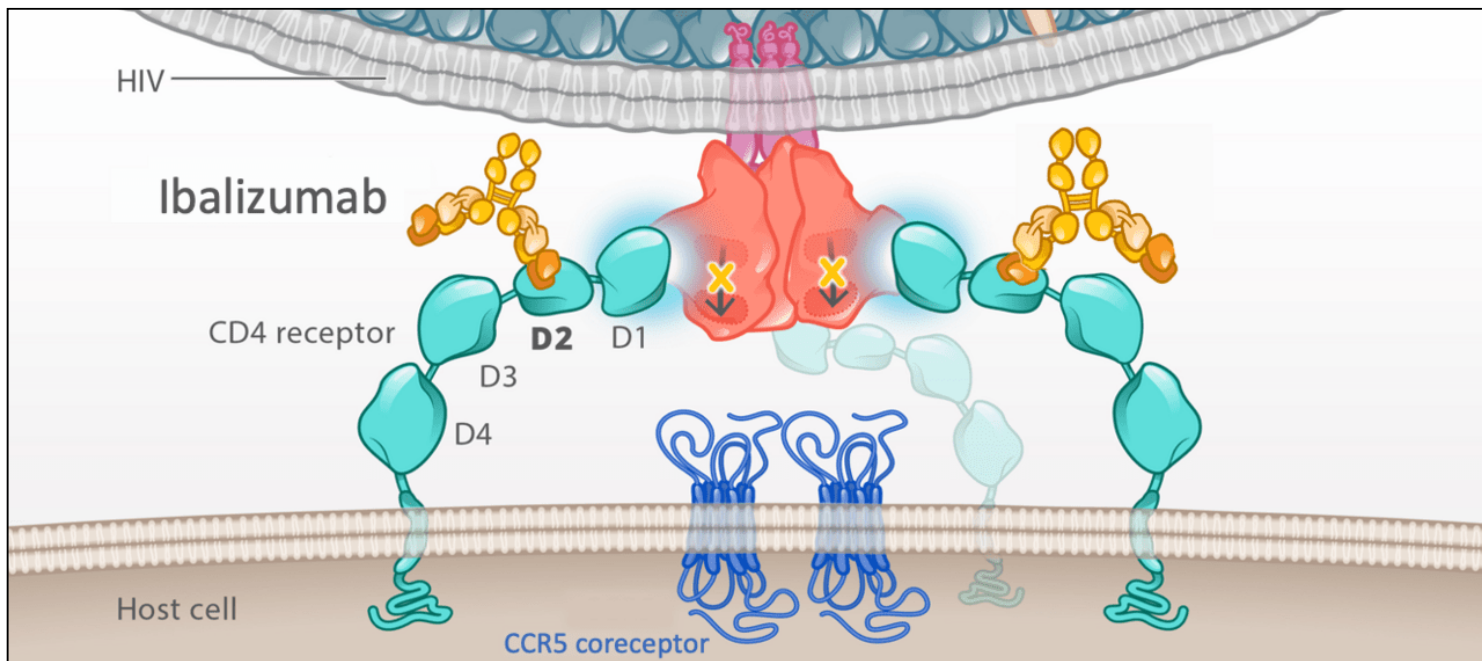

Figure 5 (Image Series) - Mechanism of Action of Entry Inhibitors
Image 5C: Mechanism of Action of CCR5 Antagonists: Maraviroc

The CCR5 antagonist maraviroc binds to the host CCR5 coreceptor, rendering a conformational change in the coreceptor, which causes unfavorable binding of the V3 region of gp120 in the R5 strains of HIV.

Illustration: Cognition Studio, Inc. and David H. Spach, MD

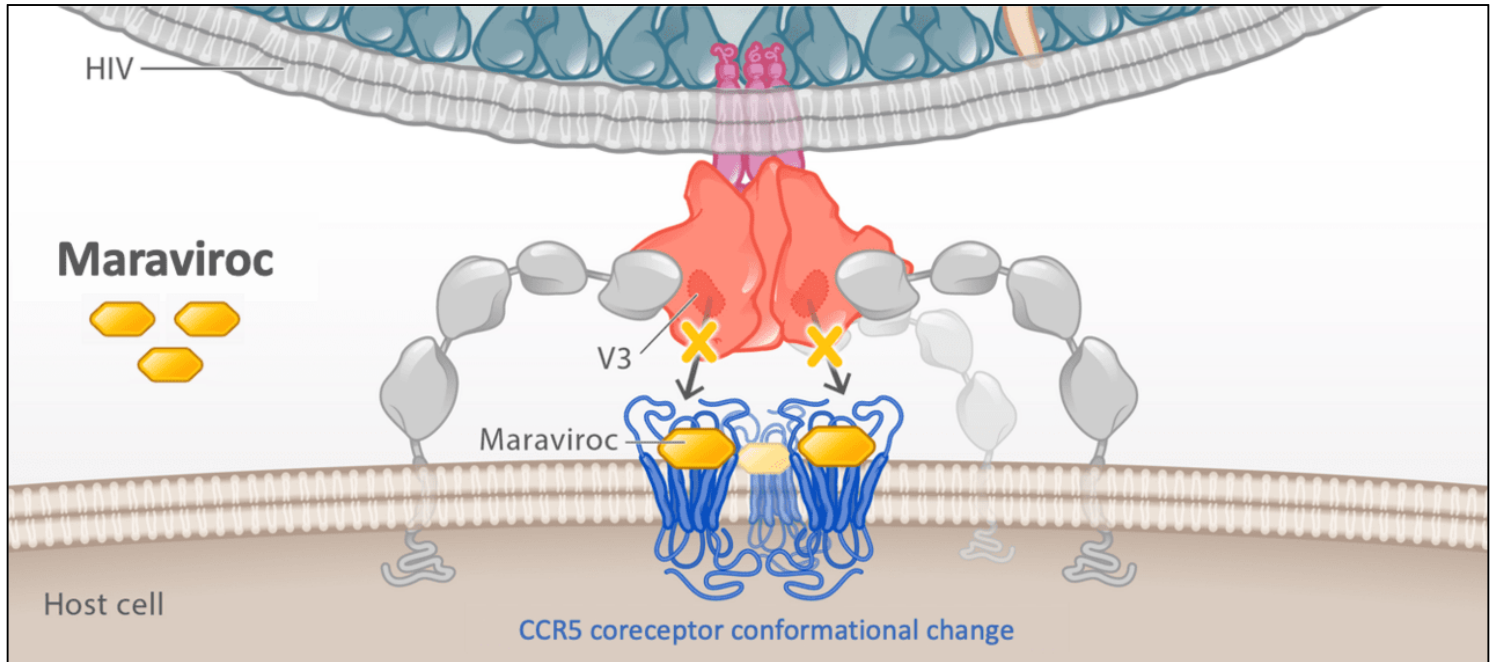

Figure 5 (Image Series) - Mechanism of Action of Entry Inhibitors
Image 5D: Mechanism of Action of Fusion Inhibitor: Enfuvirtide

The fusion inhibitor enfuvirtide is a 36-amino-acid peptide that represents a segment of the HIV gp41 HR2 domain. In the native gp41 configuration, a segment of gp41 folds back on itself and this involves tight coiling of the HR1 and HR2 segments. The drug enfuvirtide mimics the HR2 segment and binds to HR1, thus interfering with the normal HR1 and HR2 interaction.

Illustration: Cognition Studio, Inc. and David H. Spach, MD

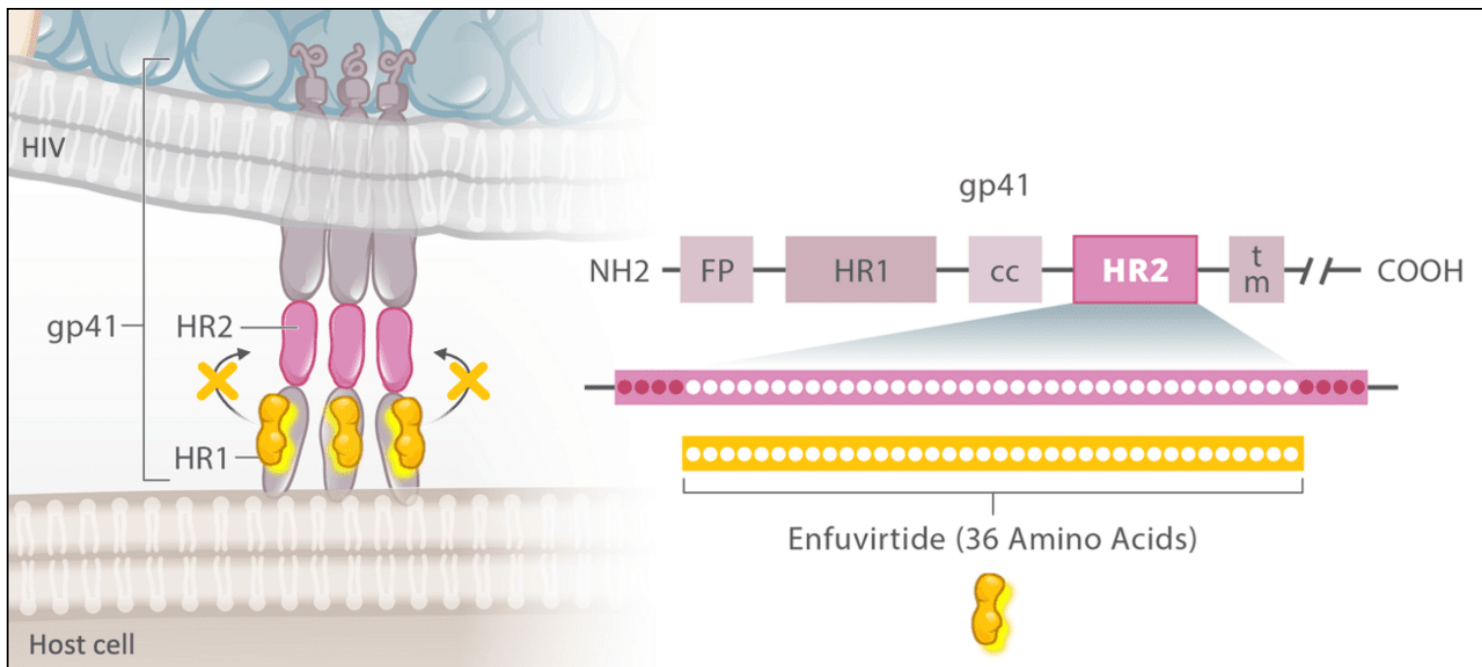

Figure 6 (Image Series) - Structure of HIV Reverse Transcriptase (Image Series) - Figure 6 (Image Series) - Structure of HIV Reverse Transcriptase
Image 6A: HIV Reverse Transcriptase: p66 and p51 Subunits

Reverse transcriptase is a DNA polymerase heterodimer comprised of p66 and p51 subunits. The p66 and p51 subunits are 560 and 440 amino acids in length, respectively. These two subunits share the same first 440 amino acids.

Illustration: Cognition Studio, Inc. and David H. Spach, MD

Reverse Transcriptase

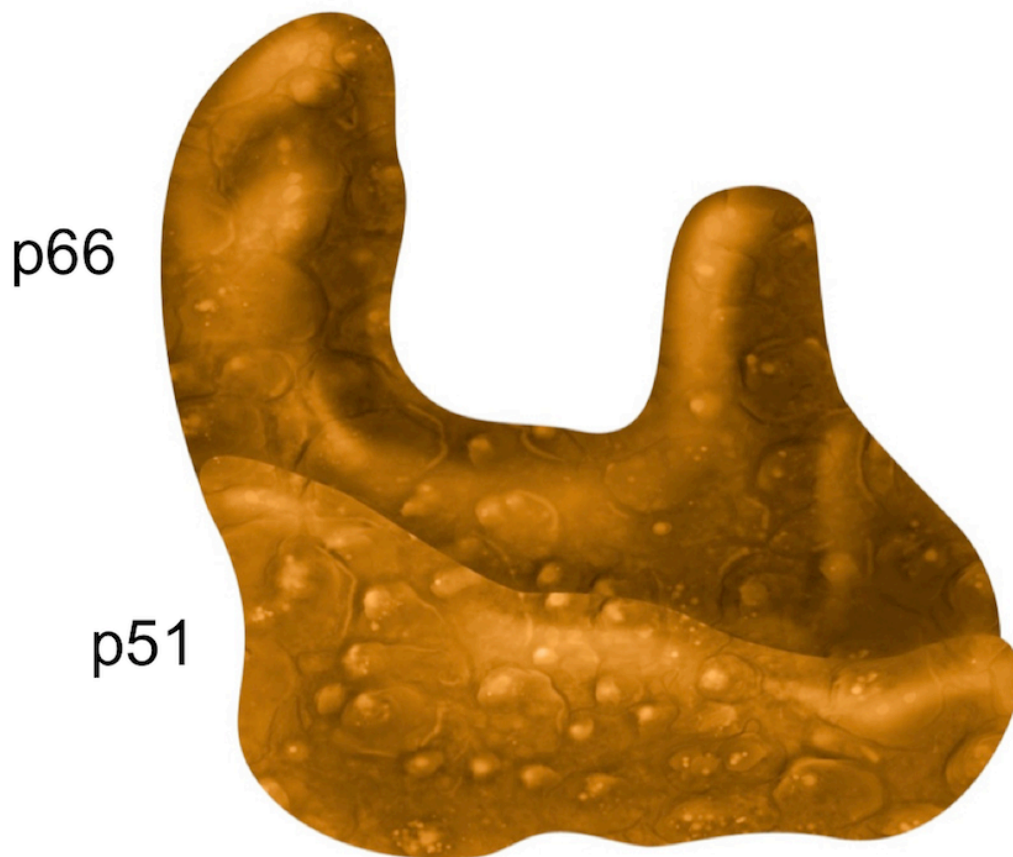

Figure 6 (Image Series) - Structure of HIV Reverse Transcriptase

Image 6B: HIV Reverse Transcriptase: p66 Subunit

The p66 subunit is 560 amino acids in length comprised of the polymerase domain (N-terminal 440 amino acids) and the RNase H domain (C-terminal 120 amino acids).

Illustration: Cognition Studio, Inc. and David H. Spach, MD

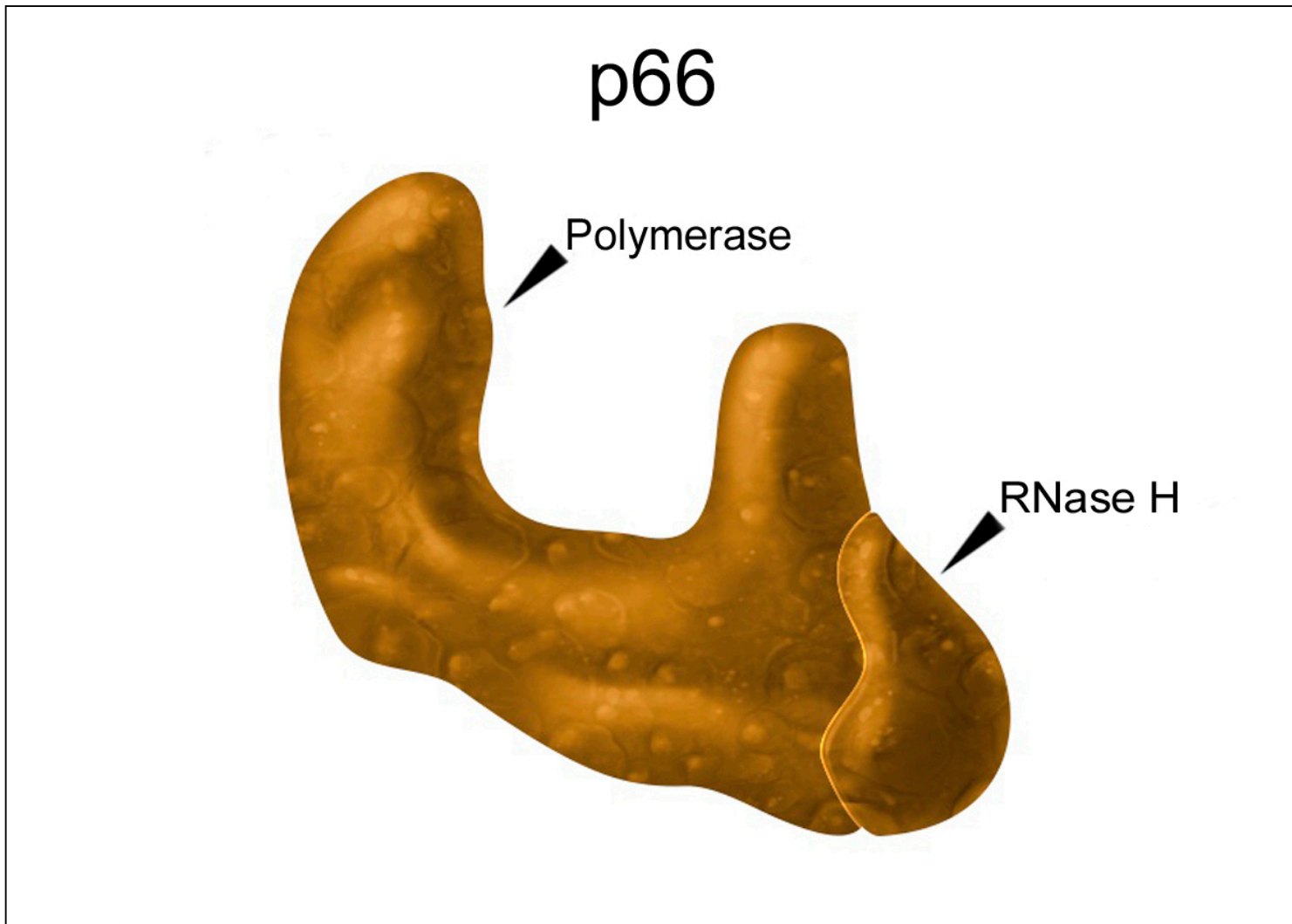

Figure 6 (Image Series) - Structure of HIV Reverse Transcriptase

Image 6C: HIV Reverse Transcriptase: Active Polymerase and RNase H Sites

The p66 subunit contains the active site for polymerase and RNase H. The polymerase active site is located in the palm subdomain of the polymerase domain and RNase H active site is in the RNase H domain.

Illustration: Cognition Studio, Inc. and David H. Spach, MD

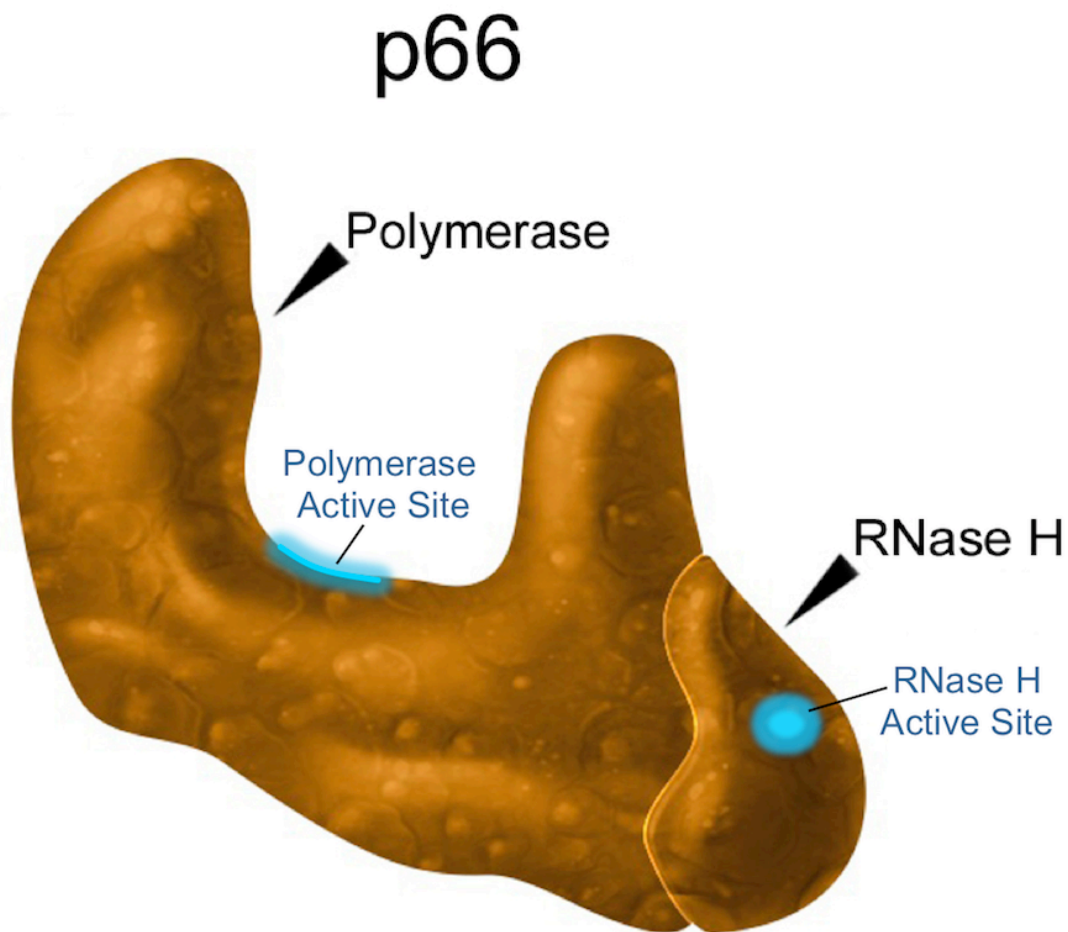

Figure 6 (Image Series) - Structure of HIV Reverse Transcriptase

Image 6D: HIV Reverse Transcriptase: Polymerase Domain

The structure of the polymerase domain resembles a right hand and consists of four domains: fingers, palm, thumb, and connection.

Illustration: Cognition Studio, Inc. and David H. Spach, MD

Polymerase Domain

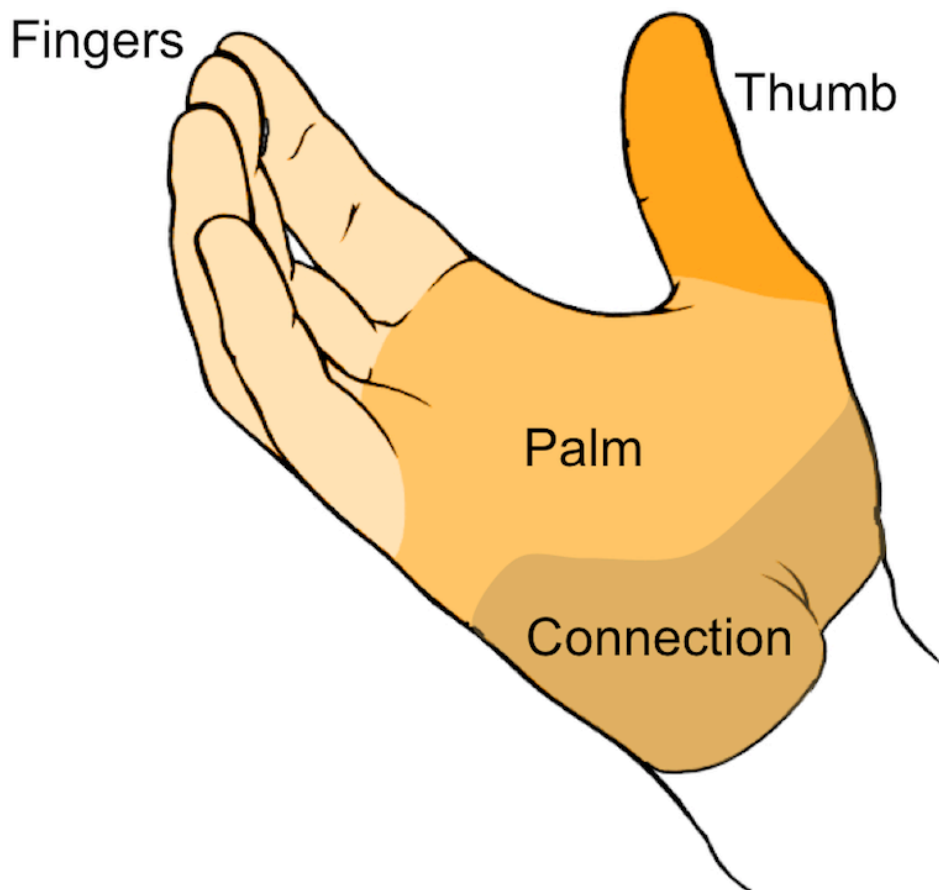

Figure 7 (Image Series) - HIV Reverse Transcription (Image Series) - Figure 7 (Image Series) - HIV Reverse Transcription

Image 7A: HIV Reverse Transcription: Conversion of RNA to DNA

The key function of HIV reverse transcriptase is to convert single-stranded HIV RNA to double-stranded HIV DNA. The actual reverse transcriptase process is a multiple-step, highly complicated process that involves polymerase, RNase H, and an RNA-DNA intermediate hybrid.

Illustration: Cognition Studio, Inc. and David H. Spach, MD

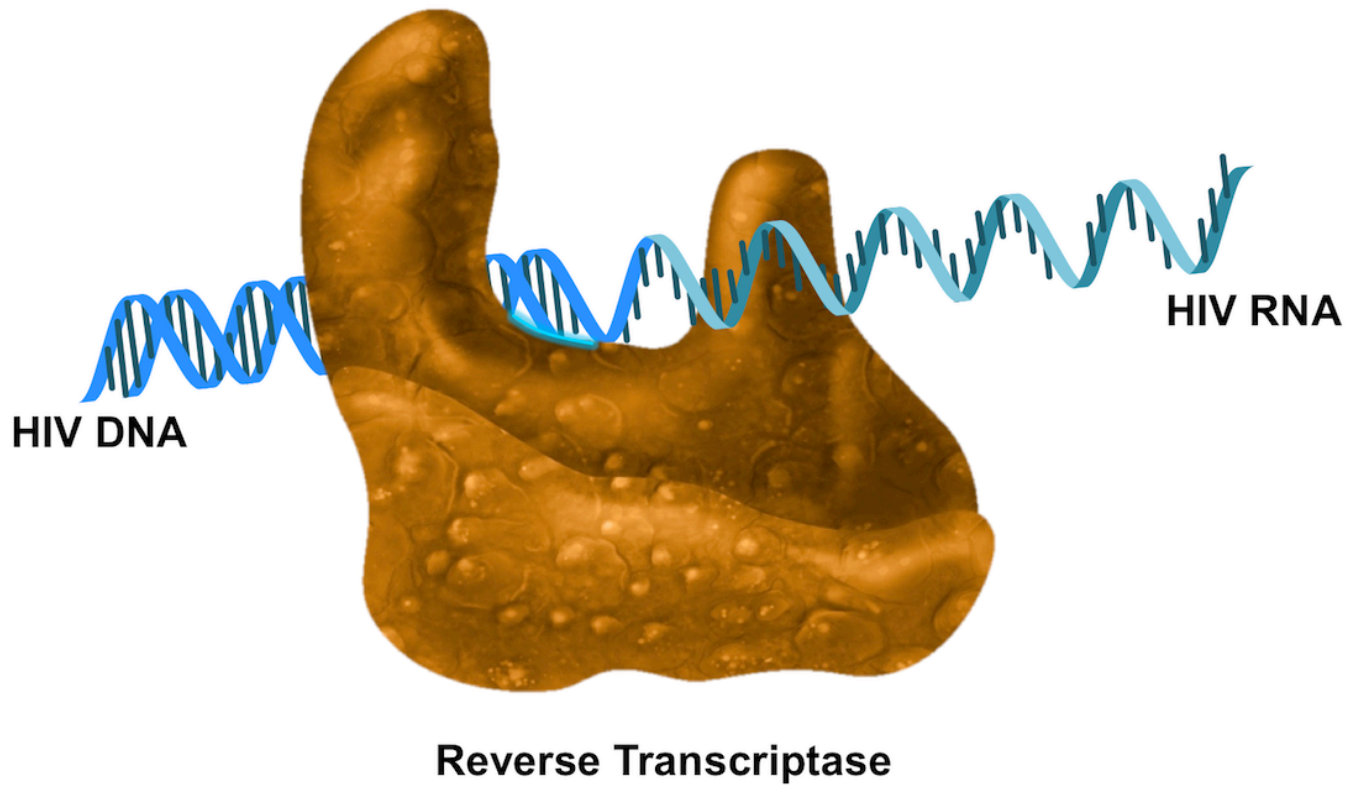

Figure 7 (Image Series) - HIV Reverse Transcription
Image 7B: HIV Reverse Transcription and Incorporation of Nucleotides

The HIV reverse transcription process occurs by incorporating human nucleotides into the elongating strand of DNA. Thus, conceptually it is important to understand the nucleotide building blocks of the HIV RNA and DNA are human in origin.

Illustration: David H. Spach, MD

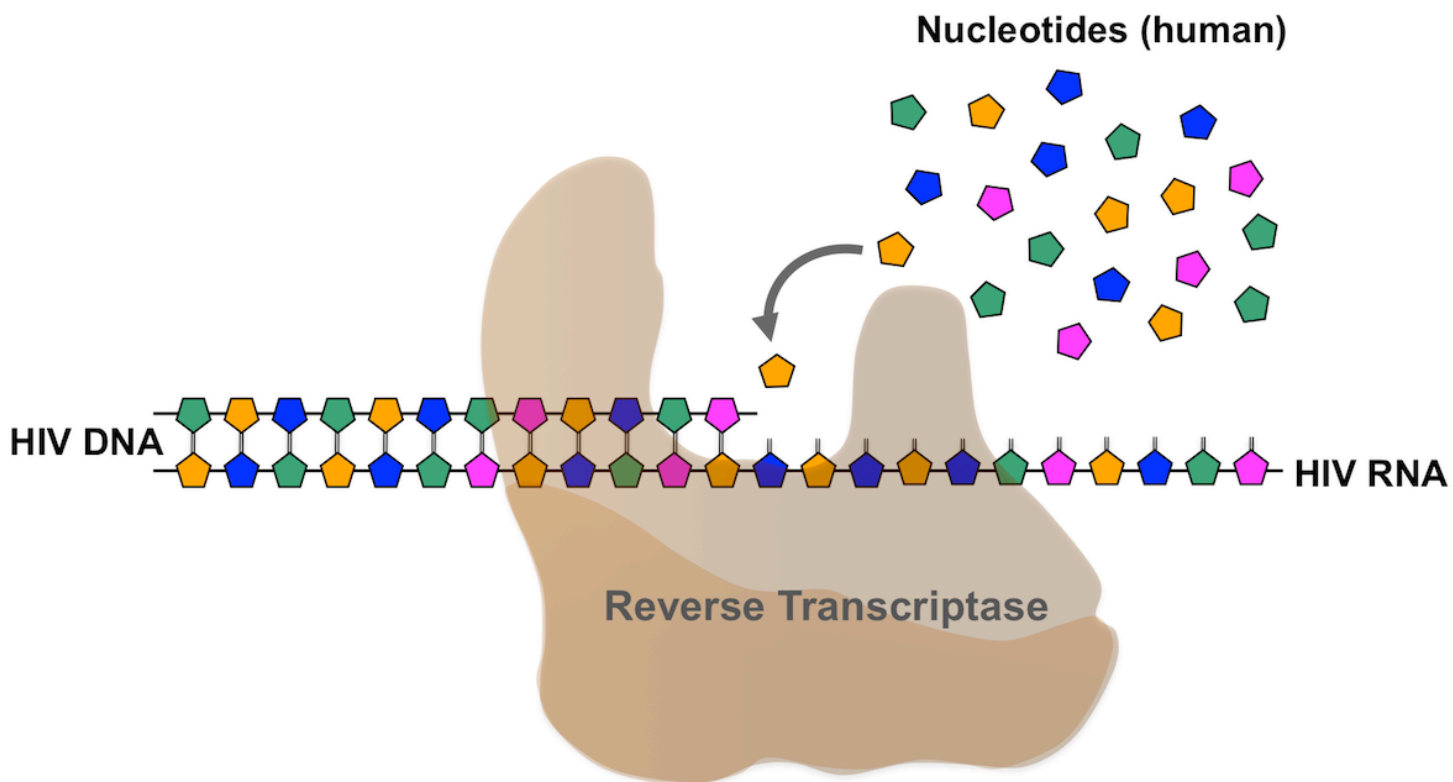

Figure 7 (Image Series) - HIV Reverse Transcription
Image 7C: Reverse Transcription: Primer and Template Strands

The reverse transcriptase, similar to other DNA polymerase enzymes, utilizes both a primer and a template. This simplified depiction shows the HIV RNA genome serving as the template and strand functioning as the primer where new nucleotides are added.

Illustration: David H. Spach, MD

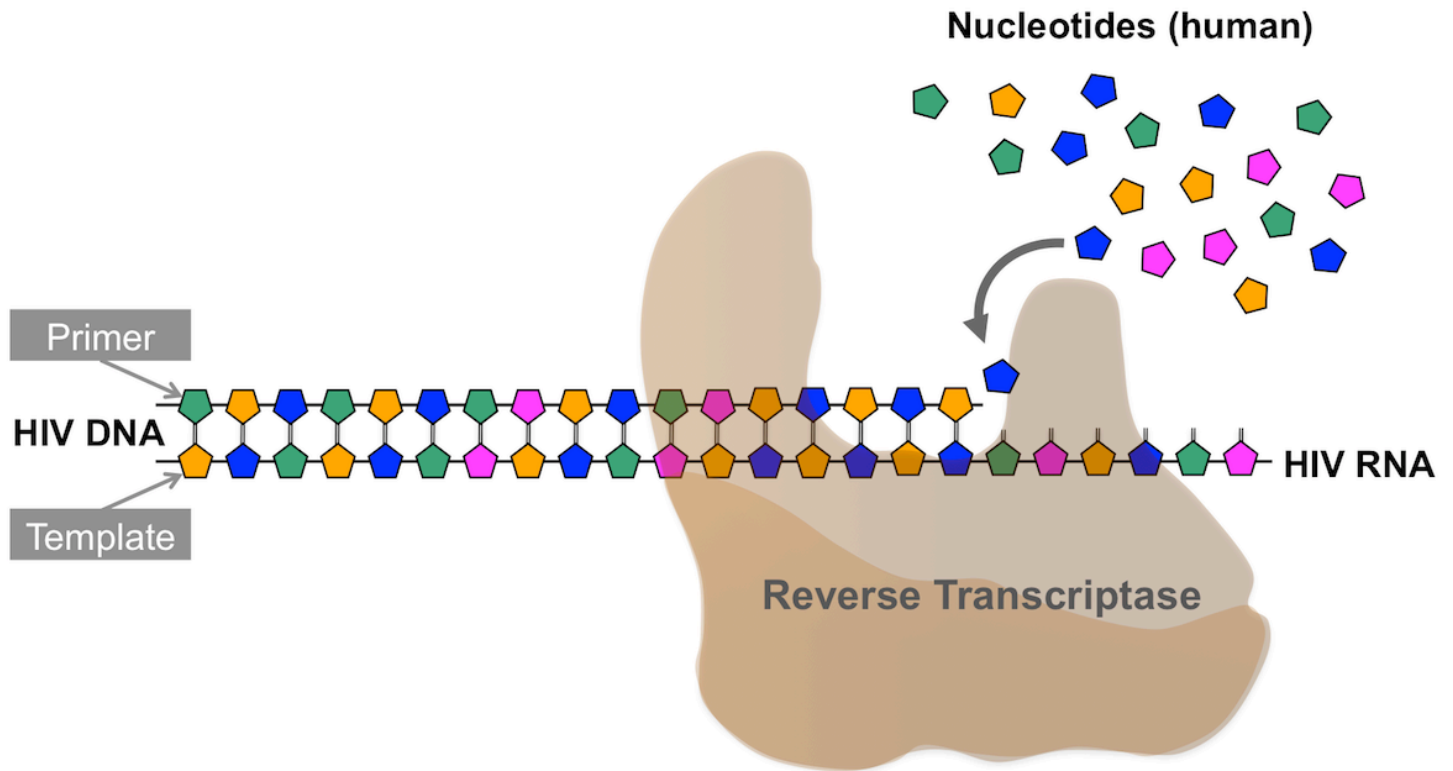

Figure 8 (Image Series) - Nucleoside Reverse Transcriptase Inhibitors: Mechanism of Action
(Image Series) - Figure 8 (Image Series) - Nucleoside Reverse Transcriptase Inhibitors: Mechanism of Action
Image 8A: Nucleoside Reverse Transcriptase Inhibitors (NRTIs)

The NRTIs, in their triphosphate form, mimic the host nucleotides that are incorporated into the elongating strand of DNA. In the active triphosphorylated form, the NRTIs compete with human nucleotides for a spot in the elongating DNA chain.

Illustration: David H. Spach, MD

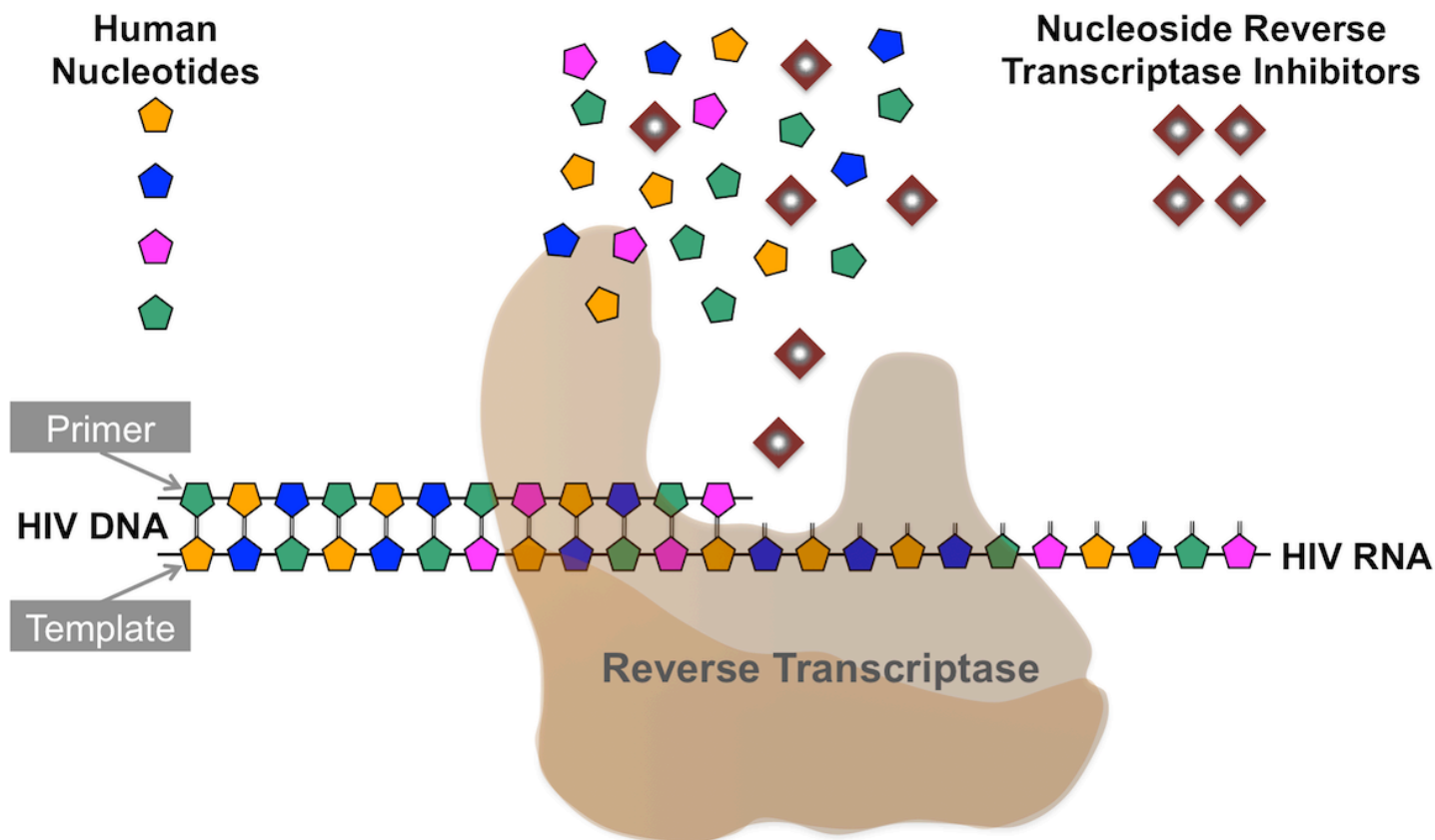

Figure 8 (Image Series) - Nucleoside Reverse Transcriptase Inhibitors: Mechanism of Action
Image 8B: Incorporation of Nucleoside Reverse Transcriptase Inhibitors (NRTIs)

After the NRTIs become activated to a triphosphate form, they can compete with human nucleotides to be incorporated into the elongating DNA chain.

Illustration: David H. Spach, MD

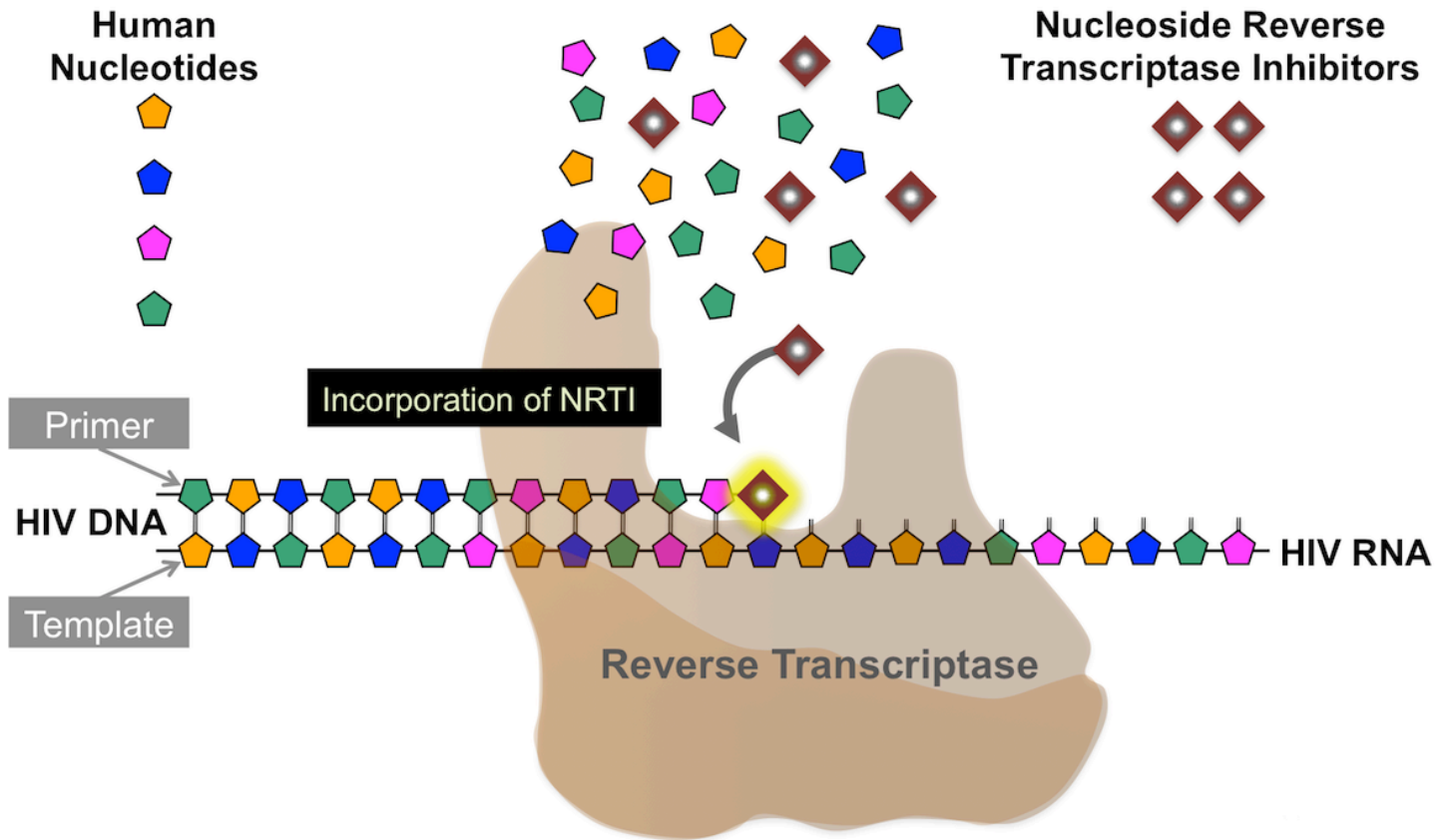

Figure 8 (Image Series) - Nucleoside Reverse Transcriptase Inhibitors: Mechanism of Action
Image 8C: Primer Blocking

The incorporation of the NRTI into the elongating strand of DNA is referred to as primer blocking.

Illustration: David H. Spach, MD

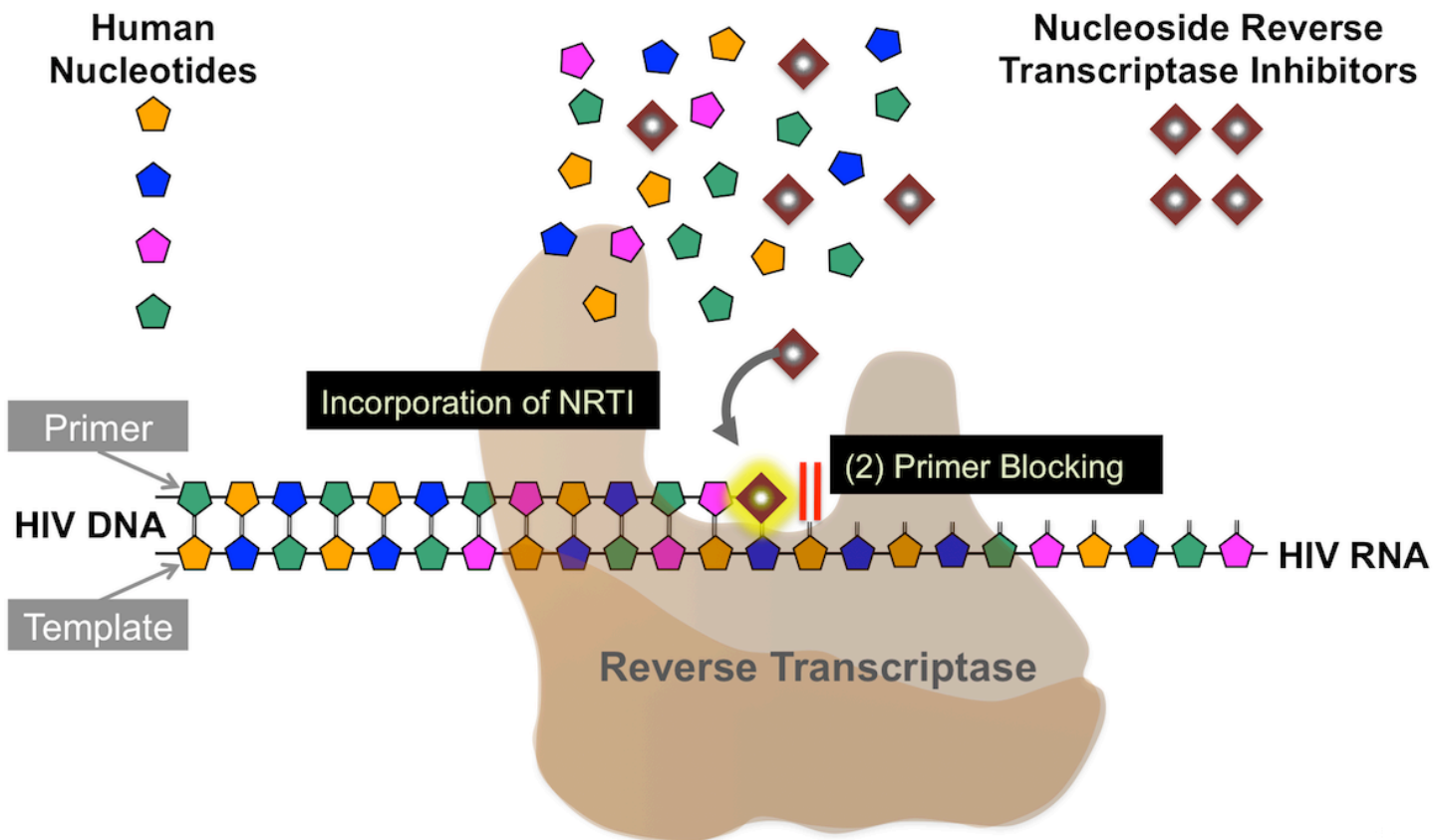

Figure 8 (Image Series) - Nucleoside Reverse Transcriptase Inhibitors: Mechanism of Action
Image 8D: Chain Termination

All NRTIs approved to treat HIV lack a 3'-hydroxyl component and thus additional nucleotides cannot be linked to the NRTI. The NRTIs thus act as chain terminators when incorporated into the viral DNA by the HIV reverse transcriptase.

Illustration: David H. Spach, MD

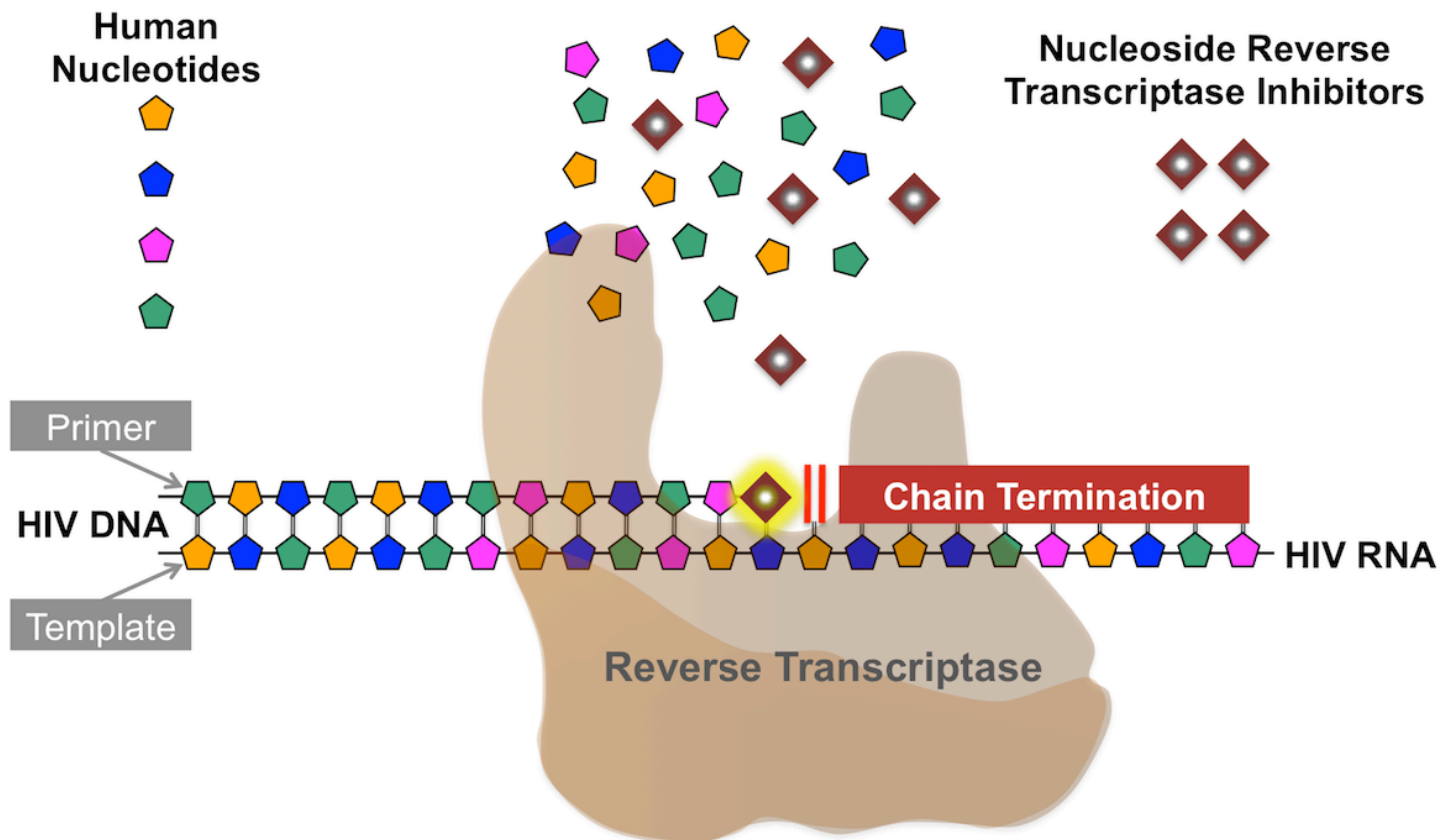

Figure 9 (Image Series) - Non-Nucleoside Reverse Transcriptase Inhibitors: Mechanism of Action
(Image Series) - Figure 9 (Image Series) - Non-Nucleoside Reverse Transcriptase Inhibitors: Mechanism of Action

Image 9A: Non-Nucleoside Reverse Transcriptase Inhibitor (NNRTI) Binding Pocket

The non-nucleoside reverse transcriptase inhibitors (NNRTIs) work by directly binding to reverse transcriptase at a binding pocket region in the polymerase domain, proximal to the polymerase active site. This binding directly impedes the function of the reverse transcriptase enzyme.

Illustration: Cognition Studio, Inc. and David H. Spach, MD

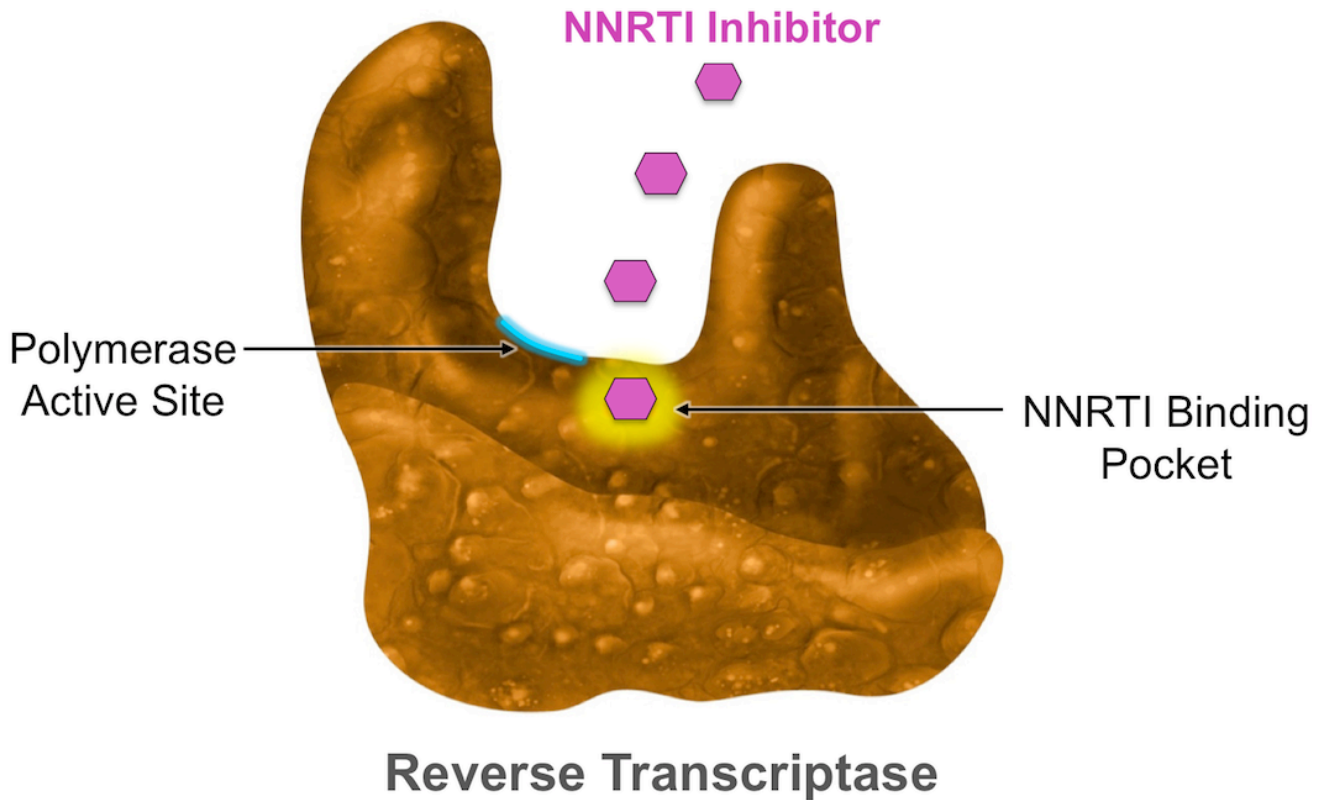

Figure 9 (Image Series) - Non-Nucleoside Reverse Transcriptase Inhibitors: Mechanism of Action
Image 9B: NNRTI-Induced Thumb Hyperextension of Reverse Transcriptase

The functional impact of NNRTI binding to reverse transcriptase is likely multifactorial, and not entirely understood; one proposed mechanism suggests that is that NNRTI binding results in a locked hyperextension of the polymerase thumb region (and also possibly with the fingers region). This conformational change is believed to alter the polymerase binding site, impacting the functional role of the reverse transcriptase.

Illustration: Cognition Studio, Inc. and David H. Spach, MD

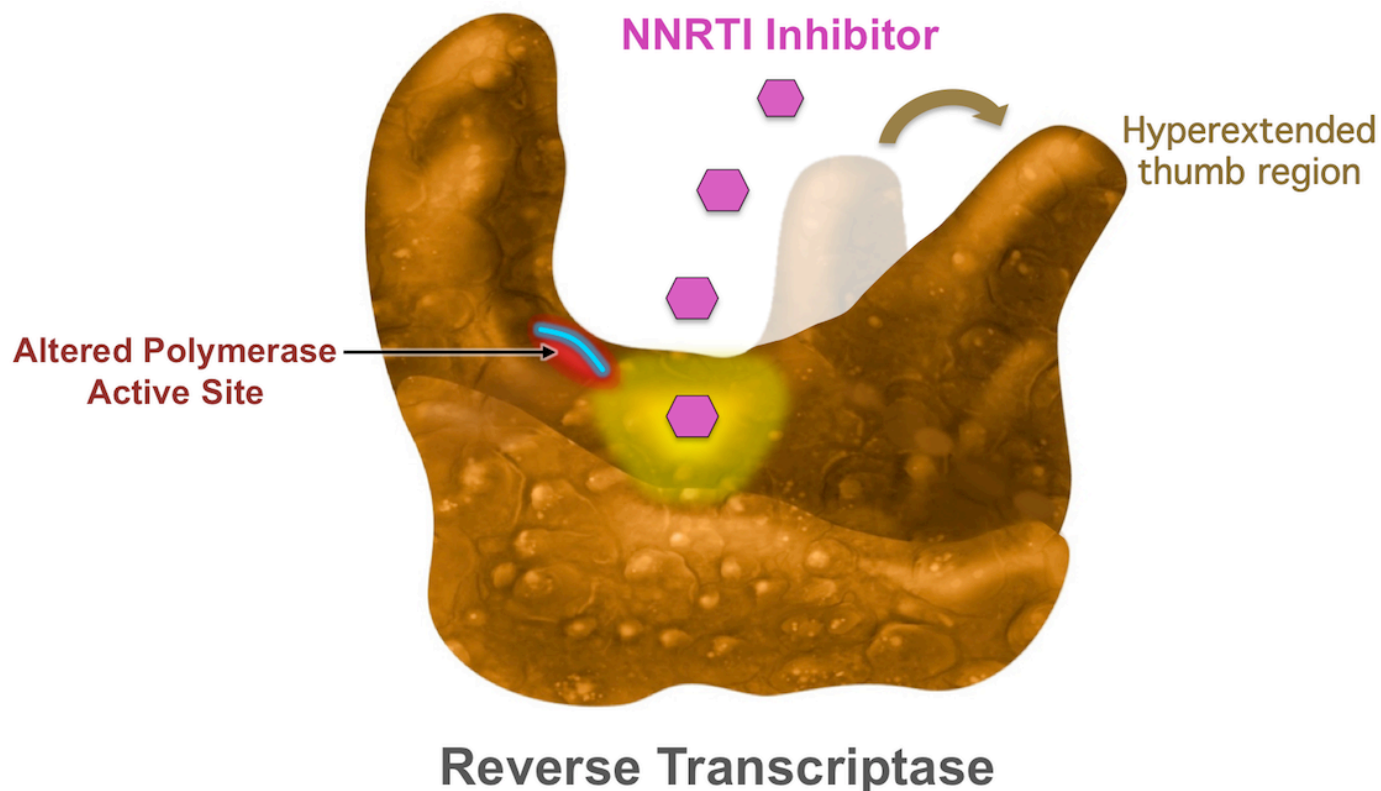

Figure 10 (Image Series) - HIV Integrase (Image Series) - Figure 10 (Image Series) - HIV Integrase

Image 10A: HIV Integrase

The HIV integrase enzyme consists of three distinct structural domains: the carboxy (C)-terminal domain, the amino (N)-terminal domain, and the catalytic core domain. The catalytic core domain contains a trio of amino acids that coordinate binding with a divalent metal (either Mg^{2+} or Mn^{2+}) and form an active catalytic site.

Illustration: Cognition Studio, Inc. and David H. Spach, MD

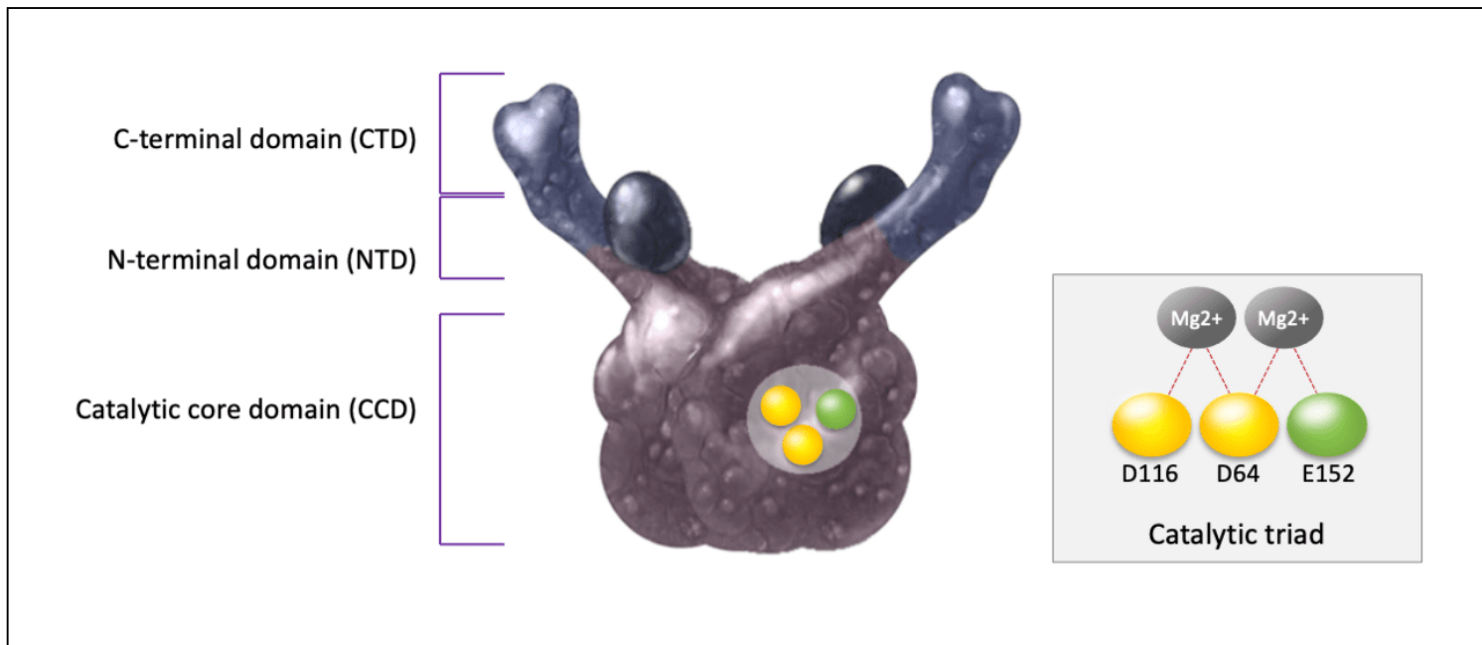

Figure 10 (Image Series) - HIV Integrase
Image 10B: HIV Integrase: Monomer, Dimer, and Tetrad Forms

The HIV integrase enzyme can exist in the form of a monomer, dimer, tetramer, and possibly higher order forms, such as octamers. Most often, it is in the dimer form.

Illustration: Cognition Studio, Inc. and David H. Spach, MD

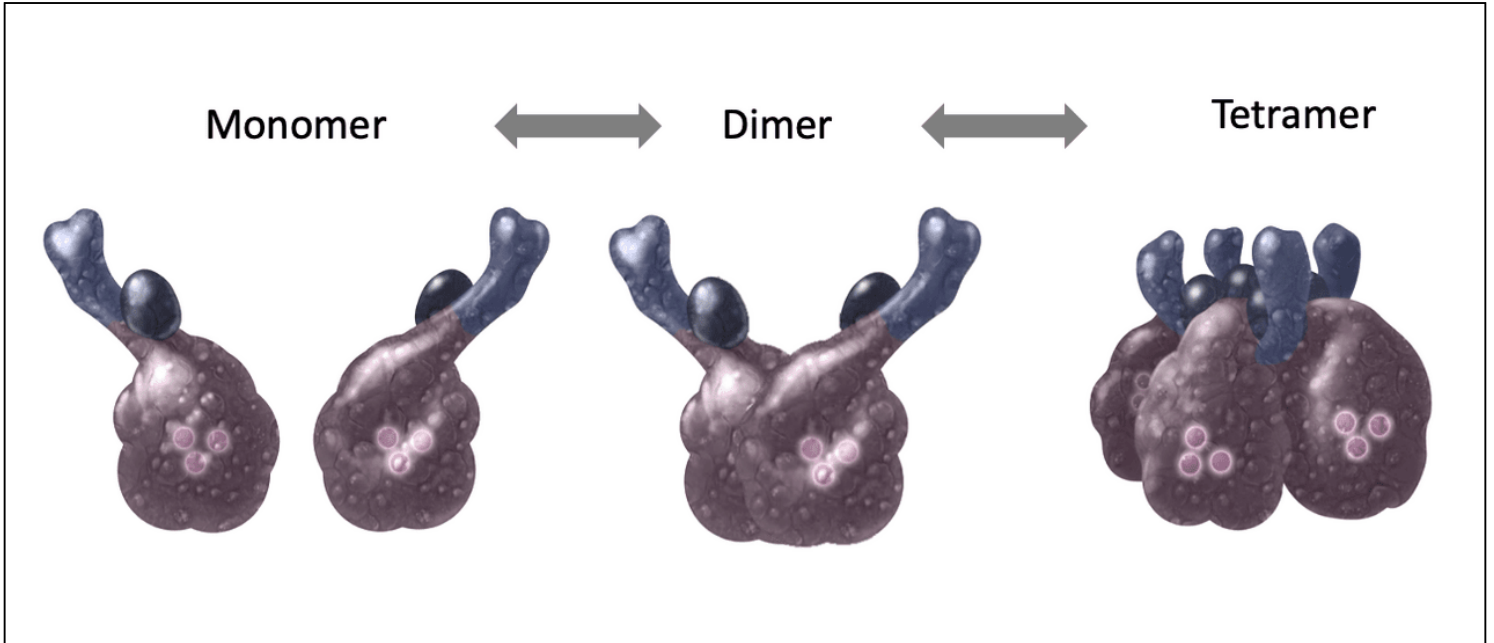

Figure 11 (Image Series) - Integration of HIV DNA into Host DNA (Image Series) - Figure 11 (Image Series) - Integration of HIV DNA into Host DNA
Image 11A: HIV Integrase: DNA Complex

The HIV integrase binds to HIV DNA (most likely in the dimer form); the integrase-HIV DNA complex is part of a particle known as the preintegration complex (or intasome). This newly formed preintegration complex has to migrate from the cytoplasm into the nucleus for integration to occur.

Illustration: Cognition Studio, Inc. and David H. Spach, MD

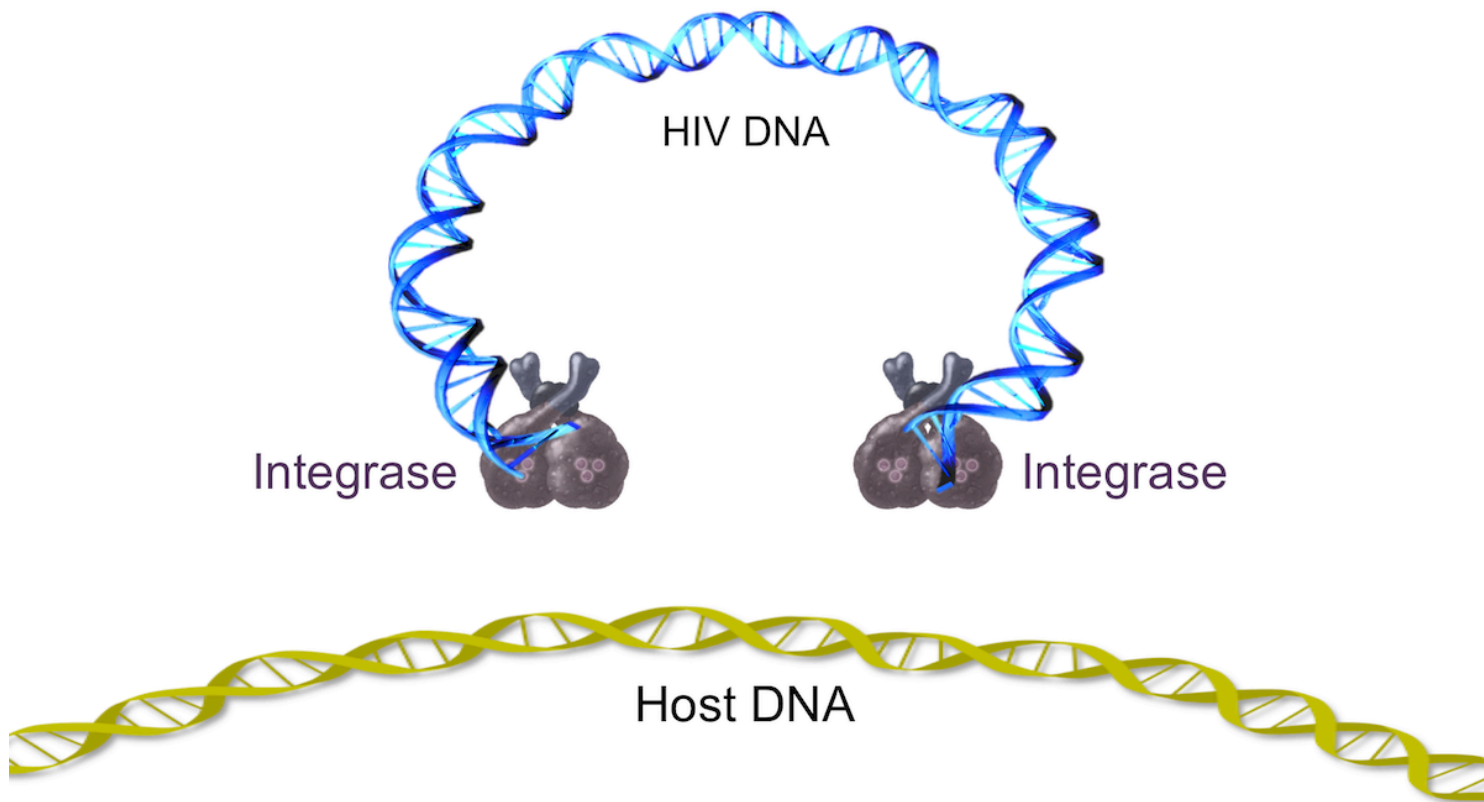

Figure 11 (Image Series) - Integration of HIV DNA into Host DNA

Image 11B: HIV Integrase Strand Transfer

This strand transfer reaction is initiated as the HIV integrase catalyzes the HIV DNA 3-hydroxyl group attack on the host DNA. The attack by the viral DNA occurs on opposite strands of the host DNA in a staggered fashion, typically 4-6 base pairs apart.

Illustration: Cognition Studio, Inc. and David H. Spach, MD

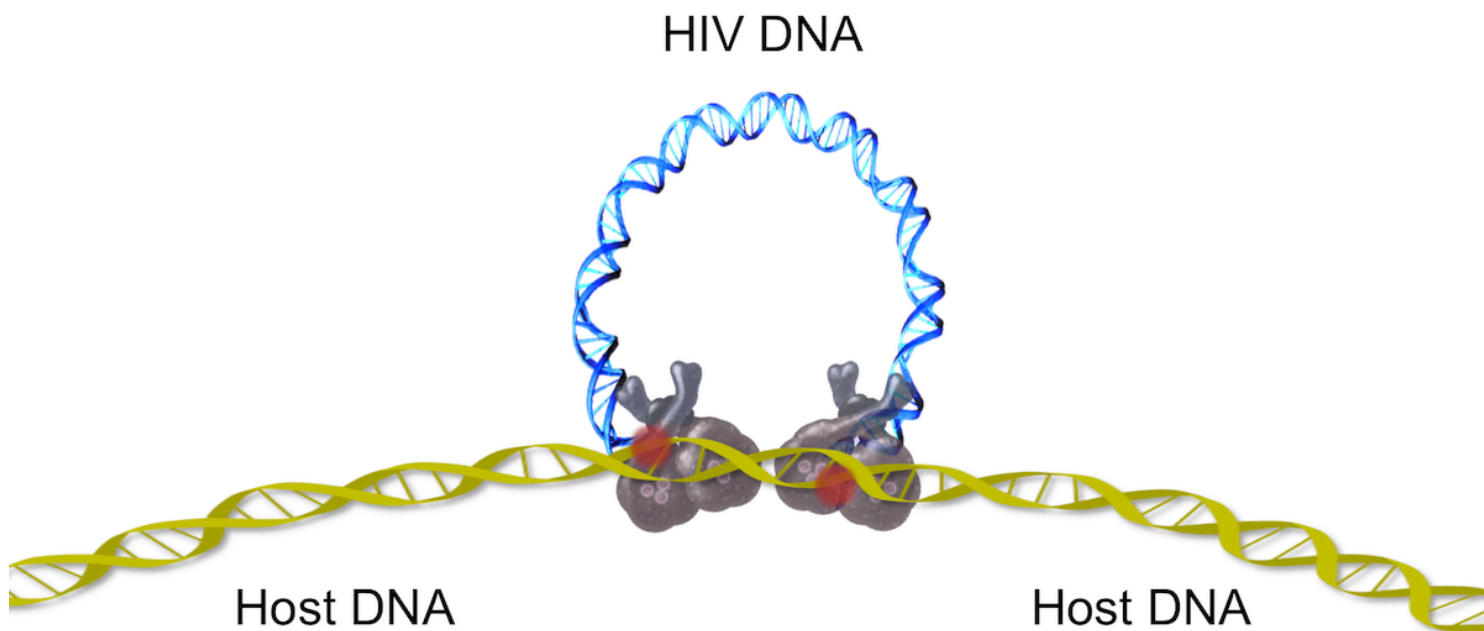

Figure 11 (Image Series) - Integration of HIV DNA into Host DNA

Image 11C: Unfolding of Integrated HIV DNA

At this point, the newly joined viral-host DNA region unfolds. The insertion of the new HIV DNA induces a host cellular DNA damage response. This host response is critical in the final step of integration, known as gap repair.

Illustration: Cognition Studio, Inc. and David H. Spach, MD

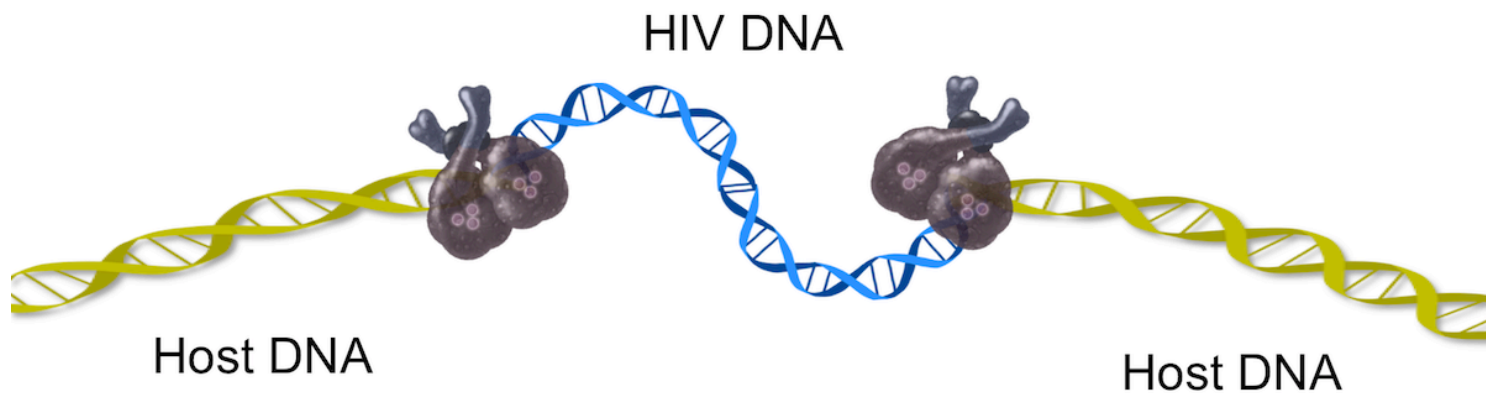

Figure 11 (Image Series) - Integration of HIV DNA into Host DNA
Image 11D: Proviral HIV DNA

The HIV DNA that is incorporated into the host DNA is referred to as proviral DNA.

Illustration: Cognition Studio, Inc. and David H. Spach, MD

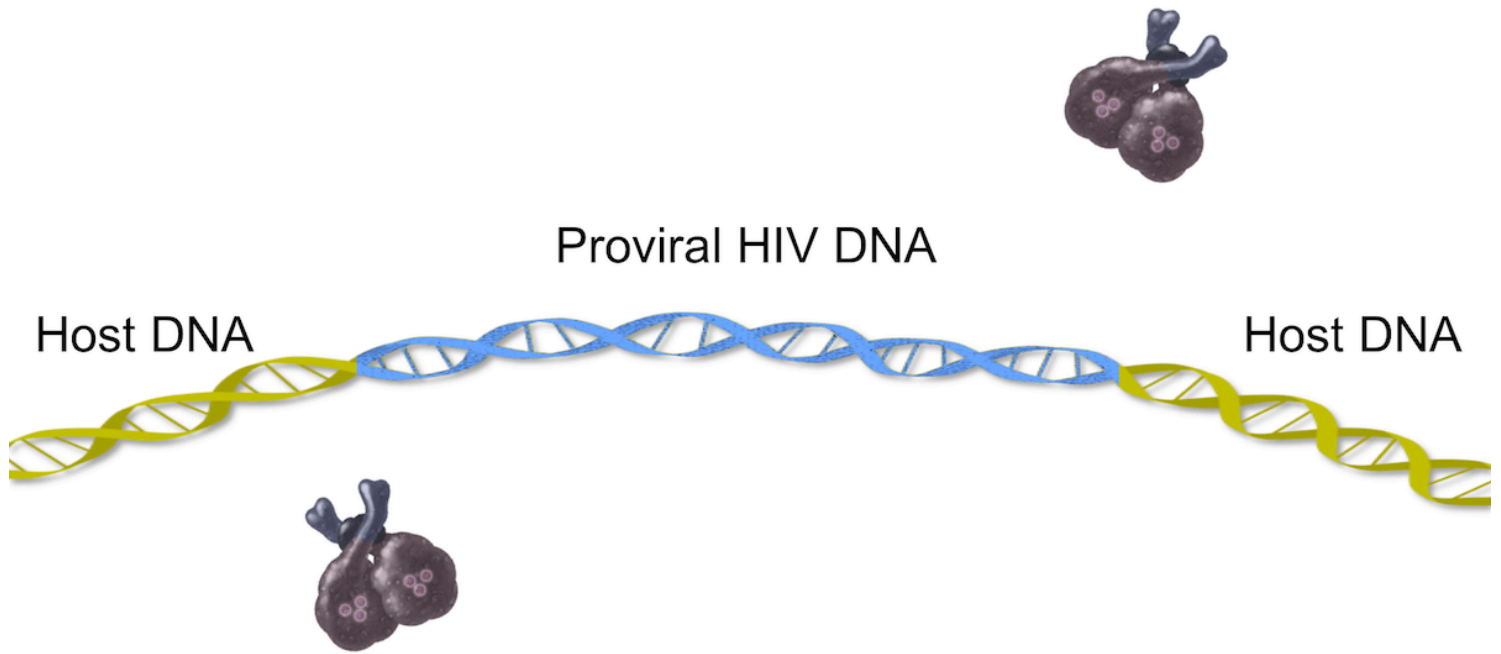

Figure 12 Integrase Strand Transfer Inhibitor

With binding to the HIV integrase, the INSTIs have a multifaceted mechanism of action that includes sequestering the Mg^{2+} ions and blocking the binding site, displacing the 3'-hydroxyl ends of viral DNA that play a critical role in strand transfer, and prevention of host DNA substrate with the HIV complex.

Illustration: Cognition Studio, Inc. and David H. Spach, MD

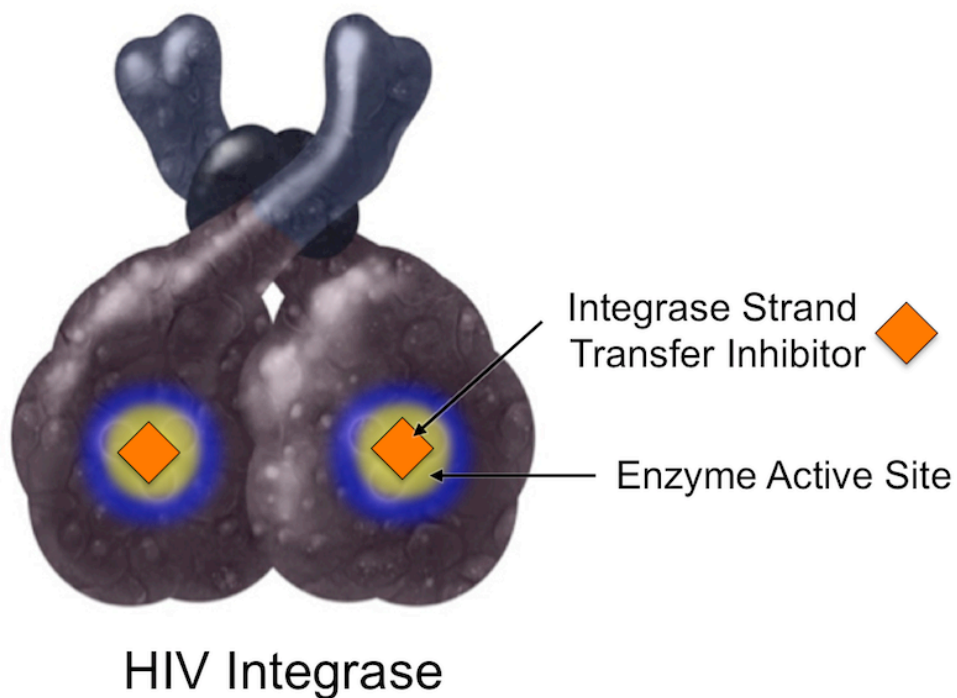

Figure 13 (Image Series) - HIV Protease Dimer and Configurations (Image Series) - Figure 13 (Image Series) - HIV Protease Dimer and Configurations
Image 13A: HIV Protease Dimer

HIV protease is a 99-amino-acid dimer made up of two identical subunits.

Illustration: Cognition Studio, Inc. and David H. Spach, MD

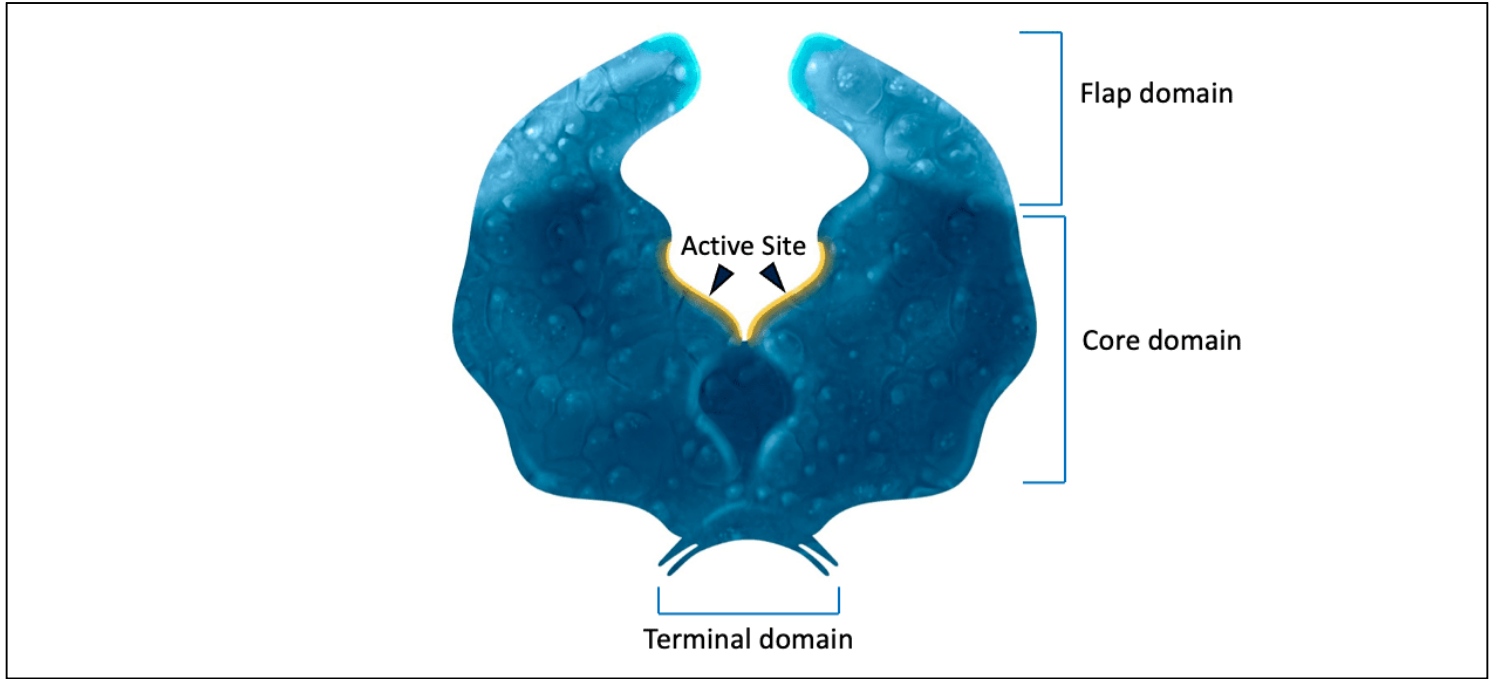

Figure 13 (Image Series) - HIV Protease Dimer and Configurations
Image 13B: HIV Protease Configurations

This figure shows the HIV protease enzyme in three configurations: open, semi-closed, and closed.

Illustration: Cognition Studio, Inc. and David H. Spach, MD

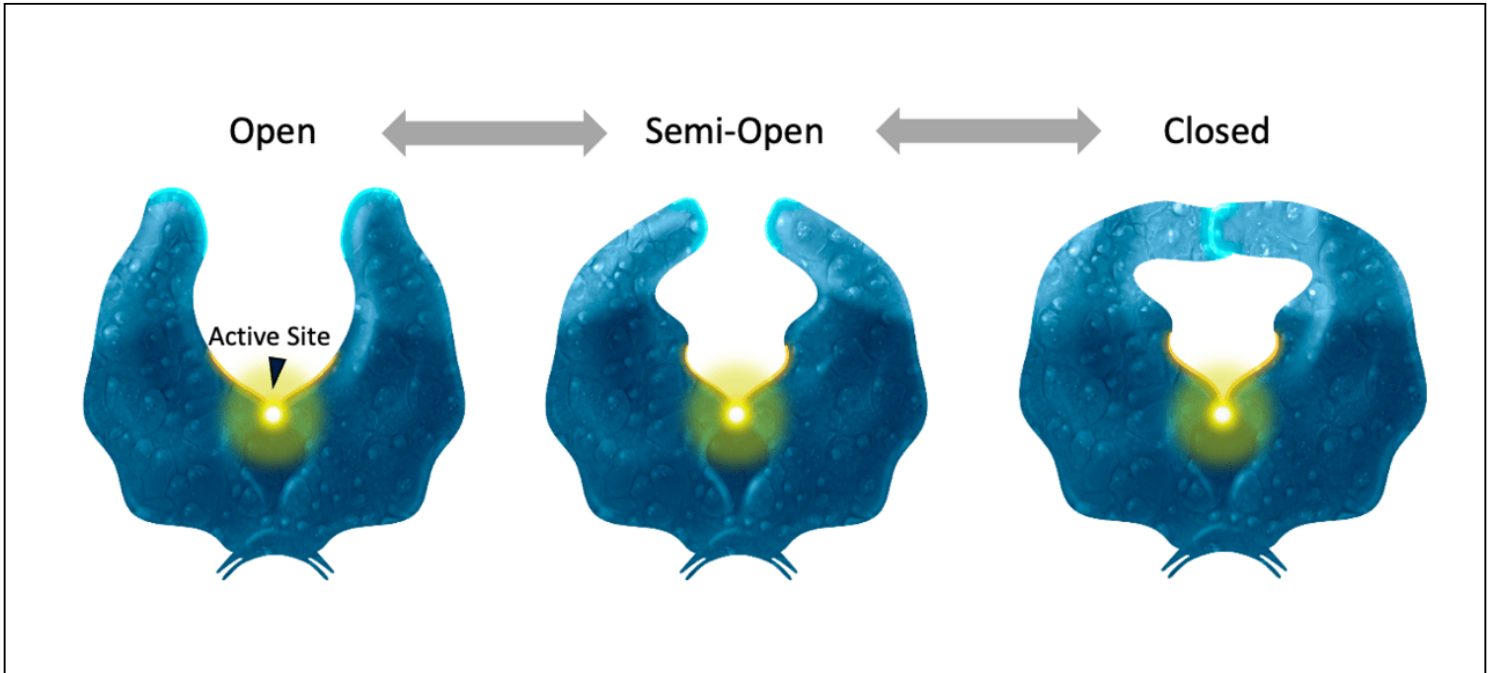

Figure 14 Sequential Steps in HIV Gag Protein Processing by HIV Protease

The HIV Gag protein processing occurs with sequential cleavages (steps 1 to 5) by HIV protease. The end result of this process is the separation of four proteins: matrix (MA), capsid (CA), nucleocapsid (NC), and p6. This cleavage process also separates out spacer peptide 1 (SP1) and spacer peptide 2 (SP2). Myristic acid moiety (myr) plays a key role in matrix binding to the phospholipid membrane.

Illustration: David H. Spach, MD

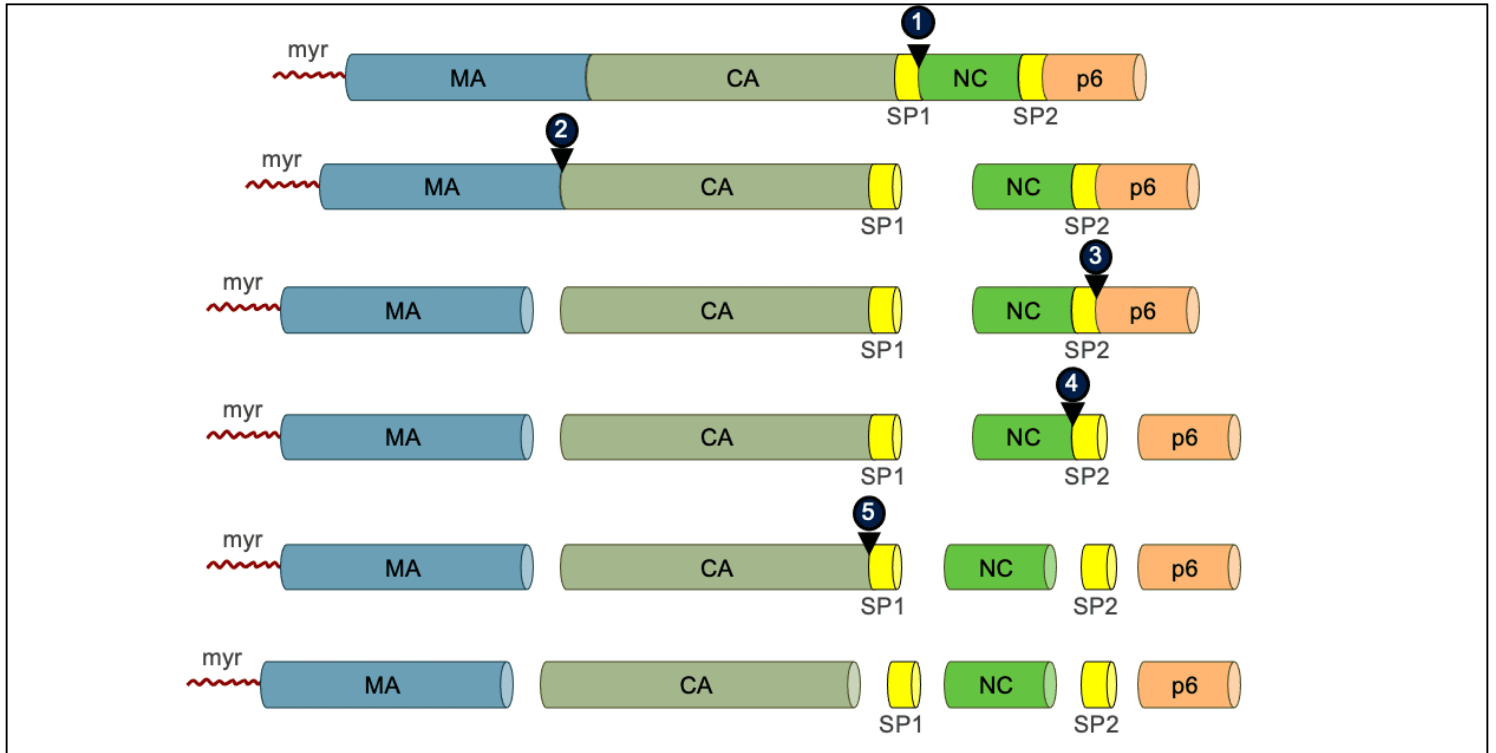

Figure 15 HIV Protease Inhibitor

The HIV protease inhibitor (red pentagon) binds to the active site of HIV protease and prevents protease processing of the Gag and Gag-Pol polyproteins.

Illustration: Cognition Studio, Inc. and David H. Spach, MD

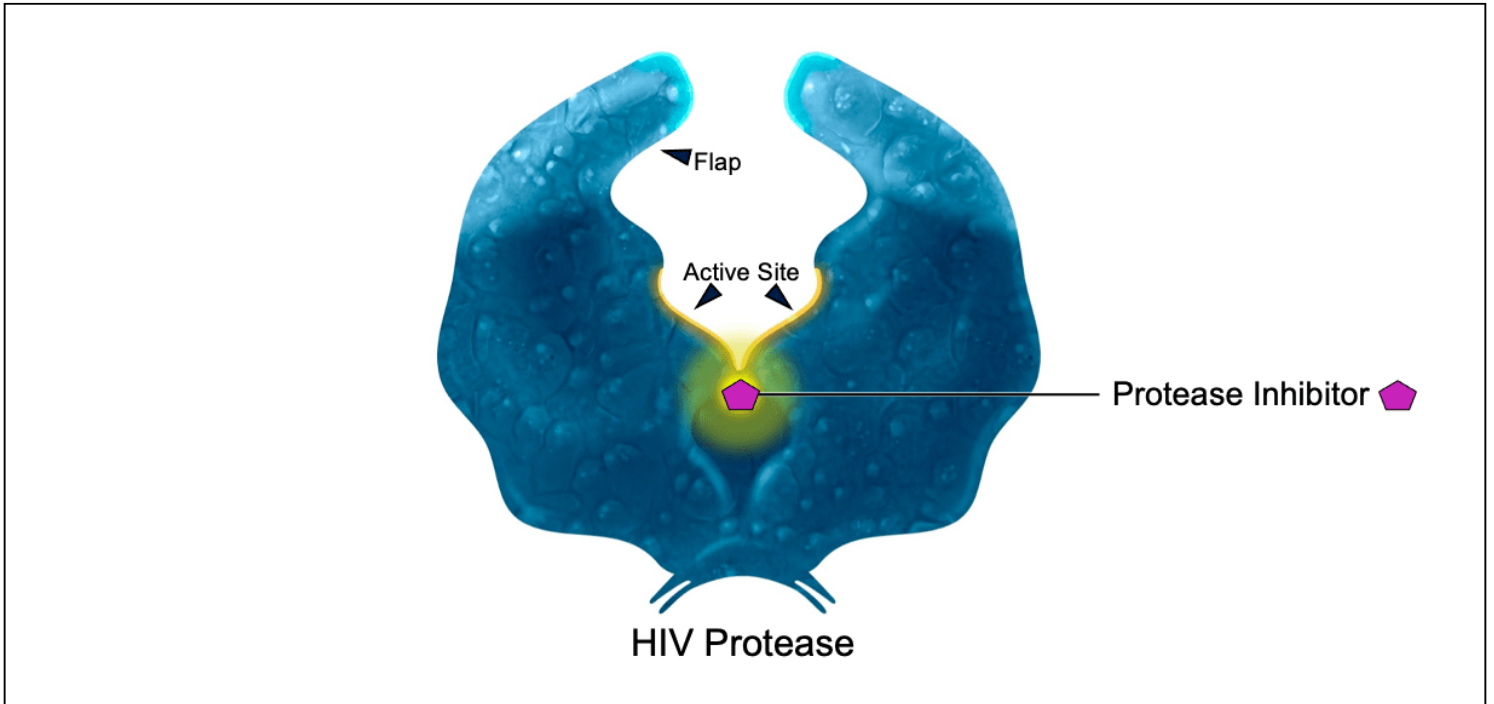

Figure 16 (Image Series) - HIV Core and Capsid Shell (Image Series) - Figure 16 (Image Series) - HIV Core and Capsid Shell
Image 16A: HIV Core and Capsid Monomer

Illustration: Cognition Studio, Inc. and David H. Spach, MD

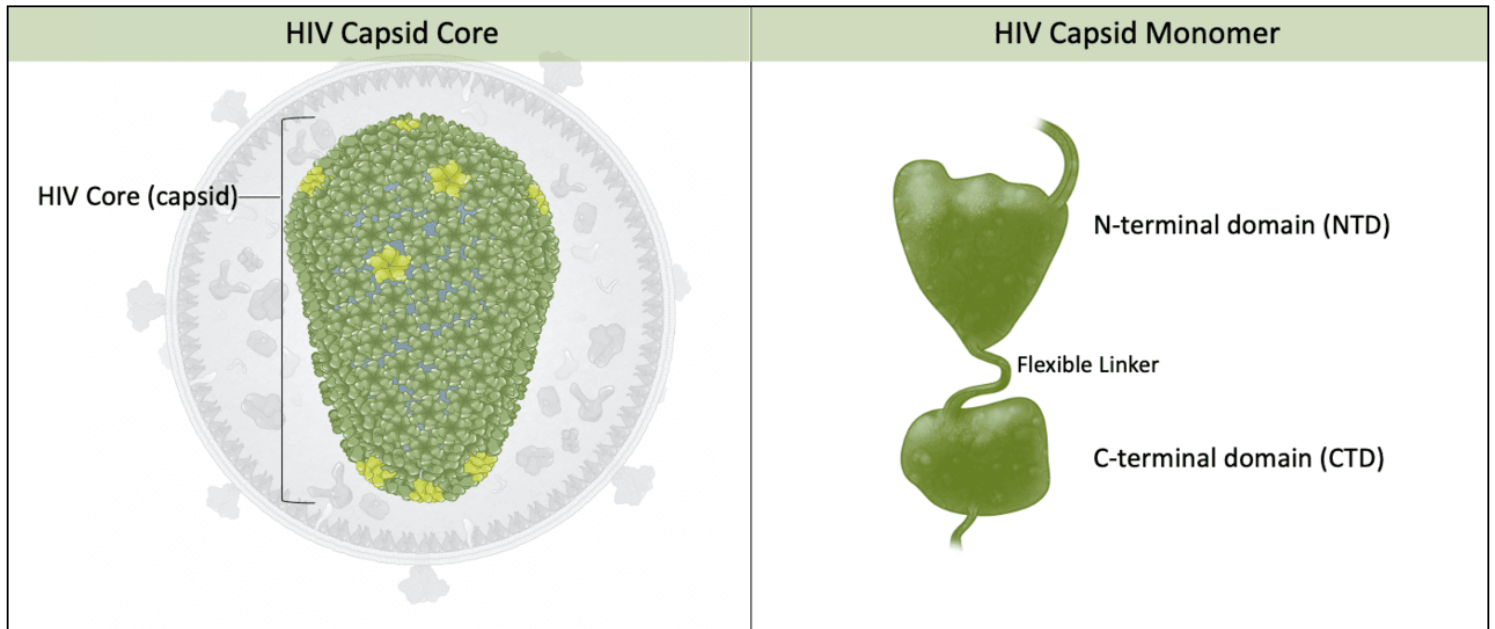

Figure 16 (Image Series) - HIV Core and Capsid Shell
Image 16B: HIV Capsid Assembly

Illustration: Cognition Studio, Inc. and David H. Spach, MD

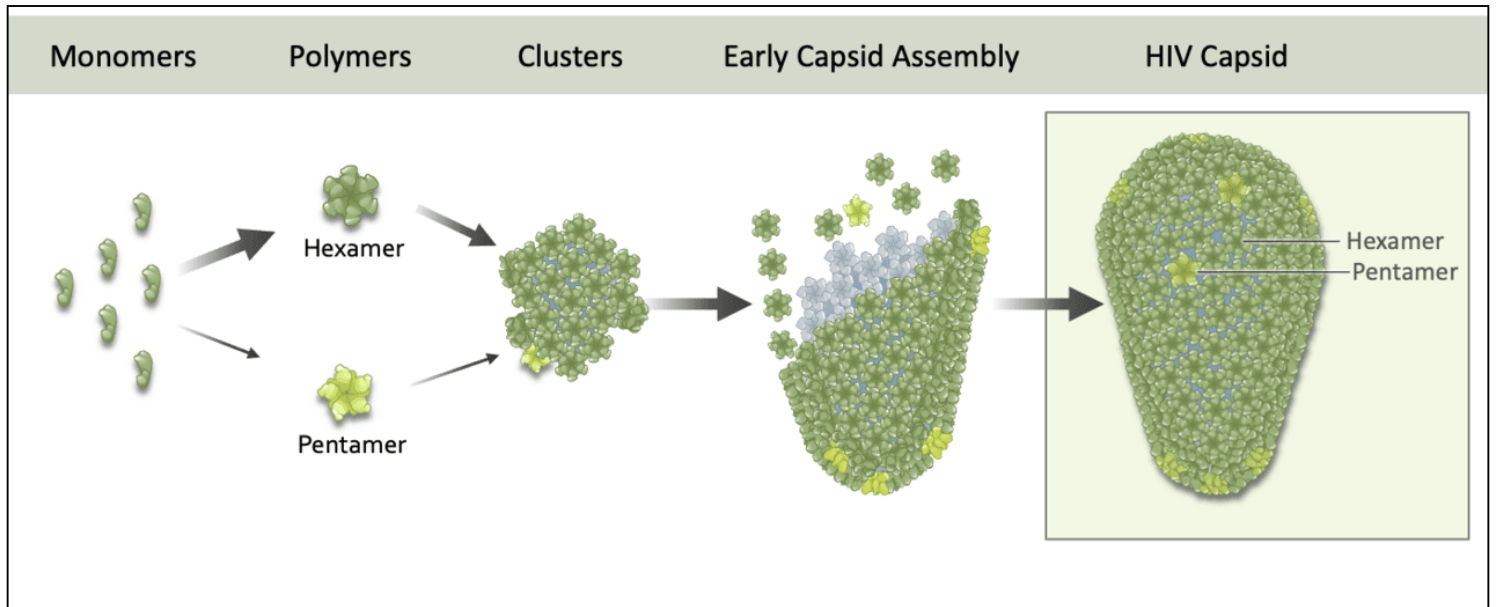

Figure 17 Mechanism of Action of Capsid Inhibitor

Illustration: Cognition Studio, Inc. and David H. Spach, MD

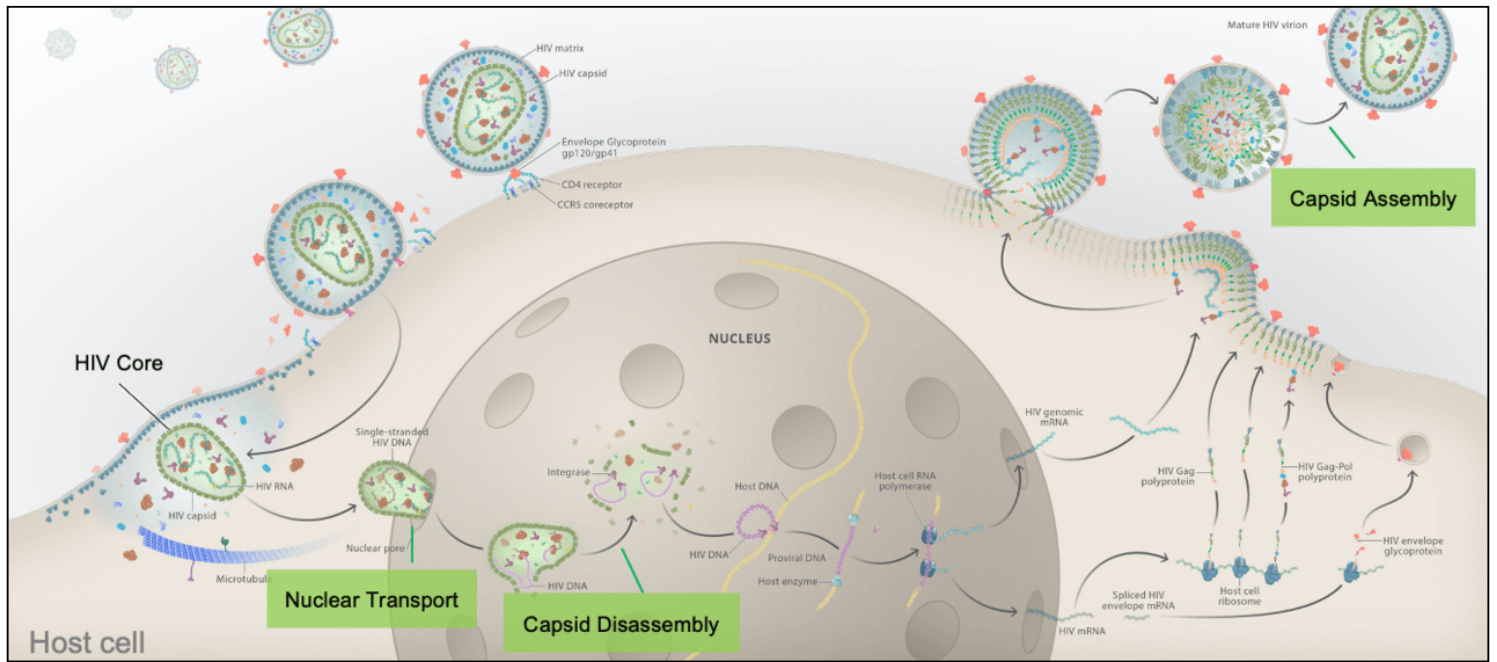

Figure 18 CD4 Cell Counts After 7 Years Of Antiretroviral Therapy, by Baseline CD4 Count

In this study, 5,299 antiretroviral therapy-naïve patients were followed to observe CD4 cell count responses after 7 years of antiretroviral therapy. The numbers shown in the bar graph indicate the median CD4 count after 7 years of antiretroviral therapy, stratified by baseline CD4 cell count group. The baseline CD4 count group strongly predicted the post-treatment absolute CD4 number.

Source: Gras L, Kesselring AM, Griffin JT, et al. CD4 cell counts of 800 cells/mm³ or greater after 7 years of highly active antiretroviral therapy are feasible in most patients starting with 350 cells/mm³ or greater. *J Acquir Immune Defic Syndr.* 2007;45:183-92.

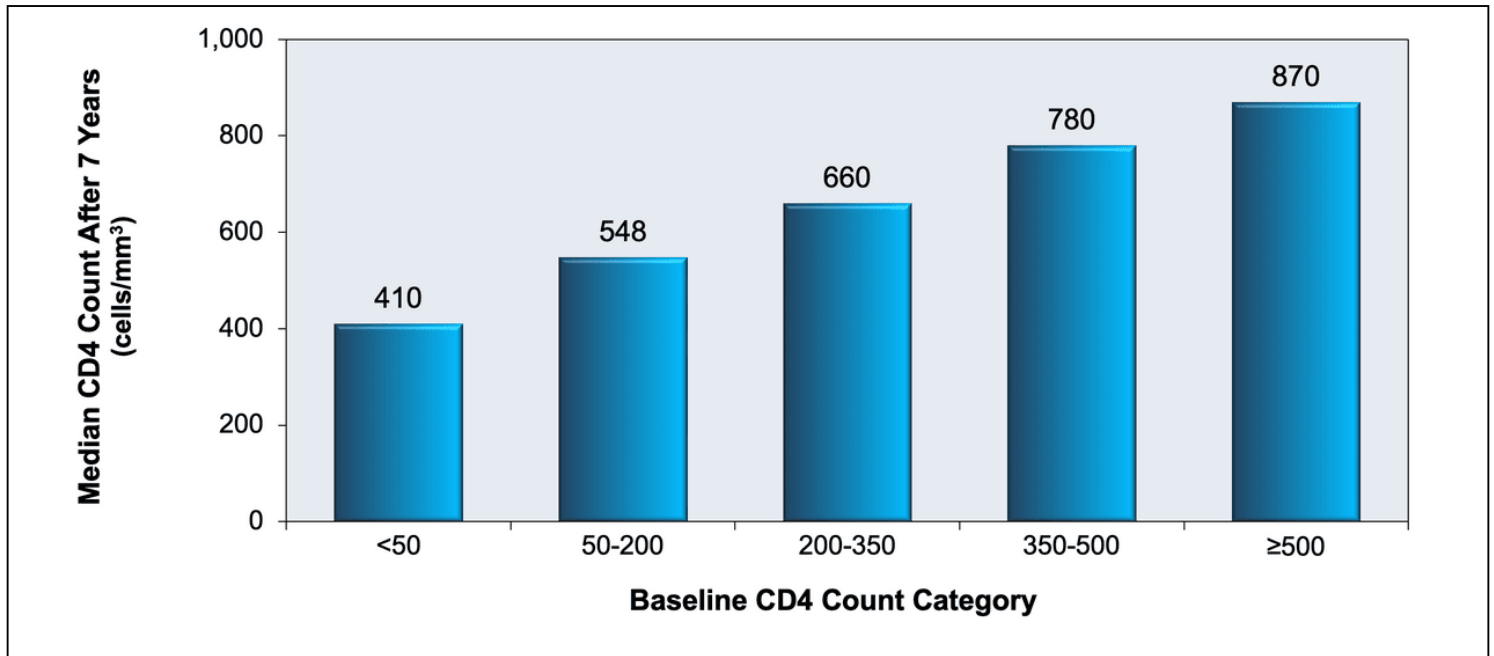

Table 1. Panel's Recommendations for Initiating Antiretroviral Therapy in Treatment-Naïve Patients
Guidelines for the Use of Antiretroviral Agents in Adults and Adolescents with HIV

Panel's Recommendations for Initiating Antiretroviral Therapy in Treatment-Naïve Patients

- Antiretroviral therapy (ART) is recommended for all individuals with HIV to reduce morbidity and mortality (AI) and to prevent the transmission of HIV to others (AI).
- Initiate ART immediately (or as soon as possible) after HIV diagnosis in order to increase the uptake of ART and linkage to care, decrease the time to viral suppression for individual patients, and improve the rate of virologic suppression among persons with HIV (AII).
- When initiating ART, it is important to educate patients regarding the benefits of ART and to deploy strategies to optimize care engagement and treatment adherence (AIII).

Rating of Recommendations: A = Strong; B = Moderate; C = Optional

Rating of Evidence: I = Data from randomized controlled trials; II = Data from well-designed nonrandomized trials or observational cohort studies with long-term clinical outcomes; III = Expert opinion

Source:

- Panel on Antiretroviral Guidelines for Adults and Adolescents. Guidelines for the use of antiretroviral agents in adults and adolescents with HIV. Department of Health and Human Services. Initiation of antiretroviral therapy. September 25, 2025. [[HIV.gov](https://www.hiv.gov)]

Table 2. Recommended Initial Regimens for Most People with HIV: Adult and Adolescent ARV Guidelines

<p>Panel's Recommendation</p>	<p>Recommended regimens are those with demonstrated durable virologic efficacy, favorable toxicity profiles, and ease of use. Choice of antiretroviral therapy during pregnancy should be based on recommendations from the Perinatal Guidelines.</p> <p>For people who do NOT have a history of long-acting cabotegravir use as HIV preexposure prophylaxis, the following regimens are recommended:</p> <ul style="list-style-type: none"> • Bictegravir-tenofovir alafenamide-emtricitabine (AI) • Dolutegravir plus (tenofovir alafenamide or tenofovir DF)^a plus (emtricitabine or lamivudine) • Dolutegravir-lamivudine (AI), except for individuals with HIV RNA >500,000 copies/mL, hepatitis B virus (HBV) coinfection, or when antiretroviral therapy is to be started before the results of genotypic resistance testing for reverse transcriptase or HBV testing are available <p>For people with HIV and a history of using long-acting cabotegravir as HIV PrEP, integrase resistance testing should be done before the start of antiretroviral therapy. If treatment is initiated before results of genotypic testing, the following regimen is recommended:</p> <ul style="list-style-type: none"> • Darunavir (boosted with cobicistat or ritonavir) plus (tenofovir alafenamide or tenofovir DF) (emtricitabine or lamivudine)—pending the results of the genotype test (AIII). <p>^aTenofovir alafenamide and tenofovir DF are two forms of tenofovir approved by the FDA. Tenofovir alafenamide has fewer bone and kidney toxicities than tenofovir DF, whereas tenofovir DF has lower lipid levels. Safety, cost, and access are among the factors to consider when choosing between these two drugs.</p> <p>Rating of Recommendations: A = Strong; B = Moderate; C = Weak Rating of Evidence: I = Data from randomized controlled trials; II = Data from well-designed observational studies, observational cohort studies with long-term clinical outcomes, relative bioavailability studies, or regimen comparisons from randomized switch studies; III = Expert opinion</p>
-------------------------------	---

Source:

- Panel on Antiretroviral Guidelines for Adults and Adolescents. Guidelines for the Use of Antiretroviral Agents in Adults and Adolescents with HIV. Department of Health and Human Services. What to Start. Initial Combination Antiretroviral Regimens for People With HIV. September 12, 2024. [[HIV.gov](https://www.hiv.gov)]

Table 3. Other Initial Antiretroviral Regimens for Certain Clinical Scenarios

Guidelines for the Use of Antiretroviral Agents in Adults and Adolescents with HIV

Other Initial Antiretroviral Regimens for Certain Clinical Scenarios

Several antiretroviral regimens are found to be effective and tolerable as initial regimens but have some disadvantages or have fewer supporting data from randomized clinical trials compared with the recommended regimens. However, one of these regimens may be preferred for an individual with HIV in certain clinical situations.

Antiretroviral Regimen	For Certain Clinical Scenarios
INSTI plus 2 NRTIs	
<p>Dolutegravir-abacavir-lamivudine (BI)—if HLA-B*5701 negative and without chronic HBV coinfection</p>	<p>When concern about renal- or bone-associated adverse effects precludes the use of tenofovir DF or tenofovir alafenamide</p>
Boosted PI plus 2 NRTIs	
<p>Darunavir-cobicistat^a plus (tenofovir alafenamide or tenofovir DF)^b plus (emtricitabine or lamivudine) (BI)</p> <p>Darunavir plus ritonavir plus (tenofovir alafenamide or tenofovir DF)^b plus (emtricitabine or lamivudine) (BI)</p>	<p>To avoid an INSTI-based regimen (e.g., documented INSTI resistance).</p>
<p>Darunavir-cobicistat^a plus abacavir-lamivudine—if HLA-B*5701 negative (BII)</p> <p>Darunavir plus ritonavir plus abacavir-lamivudine—if HLA-B*5701 negative (BII)</p>	<p>To avoid an INSTI-based regimen (e.g., with suspected documented INSTI resistance), <i>and</i></p> <p>When concern about renal or bone-associated adverse effects precludes the use of tenofovir DF or tenofovir alafenamide</p>
NNRTI plus 2 NRTIs	
<p>Doravirine-tenofovir DF^b-lamivudine (BI)</p> <p>Doravirine plus tenofovir alafenamide^b-emtricitabine (BIII)</p>	<p>To avoid an INSTI-based regimen (e.g., with suspected documented INSTI resistance), <i>and</i></p> <p>To avoid a PI-based regimen (e.g., with significant DDIs with concomitant medications)</p>

Rilpivirine-tenofovir alafenamide-emtricitabine (BII)
 Only if HIV RNA <100,000 copies/mL **and** CD4 count >200 cells/mm³

To avoid an INSTI-based regimen (e.g., with suspected documented INSTI resistance), *and*

To avoid a PI-based regimen (e.g., with significant drug drug interactions with concomitant medications), *and*

When a single-tablet regimen containing an NNRTI and tenofovir alafenamide is desired

Abbreviations: HBV = hepatitis B virus; INSTI = integrase strand transfer inhibitor; NRTI = nucleoside reverse transcriptase inhibitor; nonnucleoside reverse transcriptase inhibitor;

^aCobicistat should be avoided during pregnancy because lower concentrations of cobicistat and darunavir have been observed. For further information, refer to the Perinatal Guidelines.

^bTenofovir alafenamide and tenofovir DF are two forms of tenofovir approved by the FDA. Tenofovir alafenamide has a lower risk of weight gain while tenofovir DF is associated with lower lipid levels. Safety, cost, and access are among the factors to consider when choosing between the two.

Rating of Recommendations: A = Strong; B = Moderate; C = Weak

Rating of Evidence: I = Data from randomized controlled trials; II = Data from well-designed nonrandomized trials, cohort studies, case-control studies, outcomes, relative bioavailability/bioequivalence studies, or regimen comparisons from randomized switch studies; III = Data from case series, case reports, or expert opinion

Source:

- Panel on Antiretroviral Guidelines for Adults and Adolescents. Guidelines for the Use of Antiretroviral Agents in Adults and Adolescents with HIV. Department of Health and Human Services. What to Start. Initial Combination Antiretroviral Regimens for People With HIV. September 12, 2024. [[HIV.gov](https://www.hiv.gov)]

